



US007860536B2

(12) **United States Patent**
Jobs et al.

(10) **Patent No.:** **US 7,860,536 B2**
(45) **Date of Patent:** **Dec. 28, 2010**

(54) **TELEPHONE INTERFACE FOR A PORTABLE COMMUNICATION DEVICE**

(75) Inventors: **Steven P. Jobs**, Palo Alto, CA (US); **Scott Forstall**, Mountain View, CA (US); **Greg Christie**, San Jose, CA (US); **Bas Ording**, San Francisco, CA (US); **Imran Chaudhri**, San Francisco, CA (US); **Stephen O. Lemay**, San Francisco, CA (US); **Marcel Van Os**, San Francisco, CA (US); **Freddy Allen Anzures**, San Francisco, CA (US); **Mike Matas**, Palo Alto, CA (US)

(73) Assignee: **Apple Inc.**, Cupertino, CA (US)

(*) Notice: Subject to any disclaimer, the term of this patent is extended or adjusted under 35 U.S.C. 154(b) by 492 days.

(21) Appl. No.: **11/459,609**

(22) Filed: **Jul. 24, 2006**

(65) **Prior Publication Data**

US 2007/0155434 A1 Jul. 5, 2007

Related U.S. Application Data

(60) Provisional application No. 60/756,831, filed on Jan. 5, 2006.

(51) **Int. Cl.**
H04B 1/38 (2006.01)
H04M 1/00 (2006.01)

(52) **U.S. Cl.** **455/566**; 455/565; 455/550.1; 455/186.2; 455/401; 715/706; 715/773; 715/778; 715/800; 379/302; 379/362; 379/364; 379/433.13; 379/433.03; 379/29.1; 340/815.86; 345/589

(58) **Field of Classification Search** 455/565, 455/566, 550.1, 186.2, 401; 715/706, 773, 715/778, 800; 379/302, 362, 364, 433.13, 379/433.03, 29.1; 340/815.86; 345/589
See application file for complete search history.

(56) **References Cited**

U.S. PATENT DOCUMENTS

2,794,861 A 6/1957 Heine 379/365
5,748,512 A 5/1998 Vargas 364/709

(Continued)

FOREIGN PATENT DOCUMENTS

EP 0588210 A1 3/1994

(Continued)

OTHER PUBLICATIONS

International Search Report and Written Opinion for International Application No. PCT/US07/060120, dated May 29, 2007.

(Continued)

Primary Examiner—Patrick N Edouard
Assistant Examiner—Shantell Heiber
(74) *Attorney, Agent, or Firm*—Morgan, Lewis & Bockius LLP

(57) **ABSTRACT**

A method of using a portable communications device includes displaying a first image of a rotary dial in a display of the portable communications device in response to a first contact by a user with a click wheel. The first image of the rotary dial includes a plurality of icons arranged proximate to a periphery of the rotary dial. The plurality of icons include numbers.

30 Claims, 26 Drawing Sheets

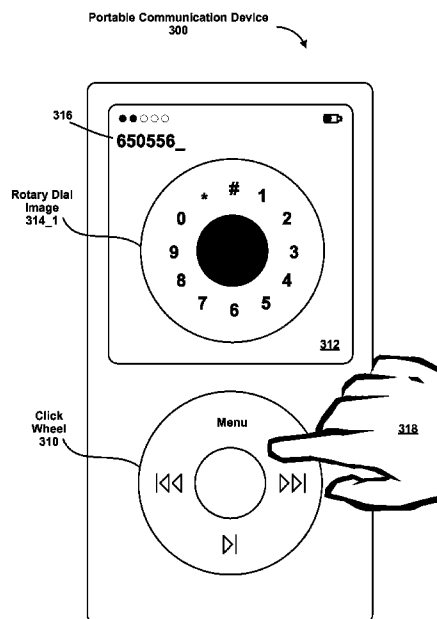

U.S. PATENT DOCUMENTS

5,801,941	A	9/1998	Bertram	364/188
5,883,612	A	3/1999	Kreitzer	345/115
5,890,181	A	3/1999	Selesky et al.	707/530
5,963,671	A	10/1999	Comerford et al.	382/230
6,011,542	A	1/2000	Durrani et al.	345/156
6,185,591	B1	2/2001	Baker et al.	707/531
6,323,846	B1	11/2001	Westerman et al.	345/173
6,359,572	B1	3/2002	Vale	341/23
6,407,325	B2*	6/2002	Yi et al.	84/610
6,570,557	B1	5/2003	Westerman et al.	345/173
6,573,844	B1	6/2003	Venolia et al.	341/22
6,597,345	B2	7/2003	Hirshberg	345/168
6,654,733	B1	11/2003	Goodman et al.	706/52
6,677,932	B1	1/2004	Westerman et al.	345/173
6,710,771	B1	3/2004	Yamaguchi et al.	345/184
6,760,012	B1	7/2004	Laurila	345/169
6,867,965	B2	3/2005	Khoo	361/686
7,107,147	B2	9/2006	Pascual et al.	701/200
7,111,788	B2*	9/2006	Reponen	235/472.01
7,149,550	B2	12/2006	Kraft et al.	455/566
7,286,115	B2	10/2007	Longe et al.	345/168
2002/0015024	A1	2/2002	Westerman et al.	345/173
2002/0030665	A1	3/2002	Ano	345/168
2002/0072394	A1*	6/2002	Muramatsu	455/566
2003/0048262	A1*	3/2003	Wu et al.	345/173
2003/0070106	A1	4/2003	Kosuda et al.	713/500
2003/0076301	A1	4/2003	Tsuk et al.	345/159
2003/0104839	A1	6/2003	Kraft et al.	455/566
2003/0162569	A1*	8/2003	Arakawa et al.	455/566
2004/0009788	A1	1/2004	Mantjarvi et al.	455/550.1
2004/0055446	A1	3/2004	Robbin et al.	84/615
2004/0070567	A1	4/2004	Longe et al.	345/156
2004/0165924	A1	8/2004	Griffin	400/486
2004/0185912	A1*	9/2004	Mason et al.	455/566
2004/0218963	A1	11/2004	Van Diepen et al.	400/472
2005/0081164	A1	4/2005	Hama et al.	715/830
2005/0125570	A1	6/2005	Olodort et al.	710/15
2005/0195159	A1	9/2005	Hunleth et al.	345/156
2005/0253818	A1	11/2005	Nettamo	345/173
2005/0283724	A1	12/2005	Griffin	715/532
2007/0046641	A1	3/2007	Lim	345/173
2007/0106732	A1	5/2007	Weis	709/206
2007/0152983	A1	7/2007	McKillop et al.	345/173

FOREIGN PATENT DOCUMENTS

EP	1510911	A2	3/2005
WO	WO 01/74133	A2	10/2001
WO	WO 2005/006442	A1	7/2005

OTHER PUBLICATIONS

“Nokia 7280 Interaktive Demos” screenshot, dated Nov. 25, 2005, <http://web.archive.org/web/2005112502636/europe.nokia.com/support/tutorials/7280/german/index.htm>, 1 page.

“Nokia 7280 Bedienungsanleitung,” dated Dec. 22, 2005, http://web.archive.org/web/20051222023851/http://ndsl.nokia.com/phones/files/guides/nokia_7280_UG-de.pdf, 149 pages.

“Synaptics: Handy wie einen iPod bedienen,” dated Sep. 21, 2004, <http://www.golem.de/0409/33706.html>, 1 page.

Day, B., “Will Cell Phones Render iPods Obsolete?” <http://weblogs.javanet/pub/wig/883>, Jan. 6, 2004.

O’Neal, W., Sr. Ed., “Smart Phones with Hidden Keyboards,” http://msc.com/4250-6452_16-6229969-1.html, Jul. 21, 2005.

Sears, A., et al., “Data Entry for Mobile Devices Using Soft Keyboards: Understanding the Effects of Keyboard Size and User Tasks,” Abstract, Int’l Journal of Human-Computer Interaction, vol. 16, No. 2, pp. 163-184, 2003.

“Microsoft’s New Smart Phone Interface: Your Thumbs,” <http://www.textually.org>, Apr. 6, 2005.

“LG Develops New Touch Pad Cell Phones,” <http://textually.org/textually/archives/2005/06/008803.htm>, Jun. 22, 2005.

“Samsung Releases Keyboard Phone in US,” <http://www.textually.org/textually/archives/2005/11/010482.htm>, Nov. 3, 2005.

“You Heard of Touch Screens Now Check Out Touch Keys,” <http://www.phoneyworld.com>, Nov. 18, 2005.

“Touch Screen Keypad for Mobile Phone by DoCoMo,” http://Casario.blogs.com/mmworld/2005/10/touch_screen_ke.html, Nov. 8, 2005.

“Fastap™ keypads redefine mobile phones,” <http://www.digitwireless.com>, 2004.

FAQ—DigitWireless, <http://www.digitwireless.com/about/faq.html>, 2004.

“Delta II—the right cell phone keypad matrix for the 21st century,” <http://www.chidagologic.com>, Nov. 2005.

“T9® Text Input for Keypad Devices,” <http://tegic.com>, Nov. 18, 2005.

“Text Input Methods,” WikiPodLinux, http://ipodlinux.org/Text_Input_Methods, Dec. 5, 2005.

“Compare keyboards with the keyboard compatibility chart, learn more about alternative keyboards,” <http://www.keyalt.com/kkeybrdp.htm>, Dec. 8, 2005.

“Technology Loan Catalog—Devices,” <http://www.tsbi.edu/outreach/techloan/catalog.html>, Nov. 3, 2004.

Office Action dated Oct. 28, 2008, for related U.S. Appl. No. 11/459,610.

Office Action dated Nov. 3, 2008, for related U.S. Appl. No. 11/459,612.

halfbakery, “Rotary cell-phone keypad,” 3 pages, Feb. 2002, http://halfbakery.com/idea/Rotary_20cel1-phone_20keypad.

Nokia, “Nokia 7280: Interactive Demonstrations,” 7 pages, 2004, http://nokia.com/EUROPE_NOKIA_COM_3/r2/support/tutorials/7280/english/index.html.

Nokia, “Nokia 7280 User Manual,” Nov. 25, 2004, 74 pages, http://ndsl.nokia.com/phones/files/guides/Nokia_7280_UG-en.pdf.

Office Action dated Jun. 25, 2009, for related U.S. Appl. No. 11/549,619.

Office Action dated Aug. 6, 2009, for related U.S. Appl. No. 11/459,612.

Gibbs, K., “I’ve Got a Suggestion,” posted on the Google Blog, Dec. 10, 2004, <http://googleblog.blogspot.com>.

Google, “Google Suggest FAQ,” Google.com, retrieved on Apr. 1, 2009, from <http://labs.google.com/suggestfaq>.

Liu, J., “At a Loss for Words?,” posted on the Google Blog, Aug. 25, 2008, <http://googleblog.blogspot.com>.

McAlister, J., “News + Suggest Join Forces,” Apr. 28, 2006, posted on the Google Blog, <http://googleblog.blogspot.com>.

Torrone, P., “Google Suggest: The Movie,” Dec. 11, 2004, posted on www.engadget.com.

Office Action dated Apr. 7, 2009, for related U.S. Appl. No. 11/459,612.

Office Action dated May 5, 2010, received in U.S. Appl. No. 11/459,612.

* cited by examiner

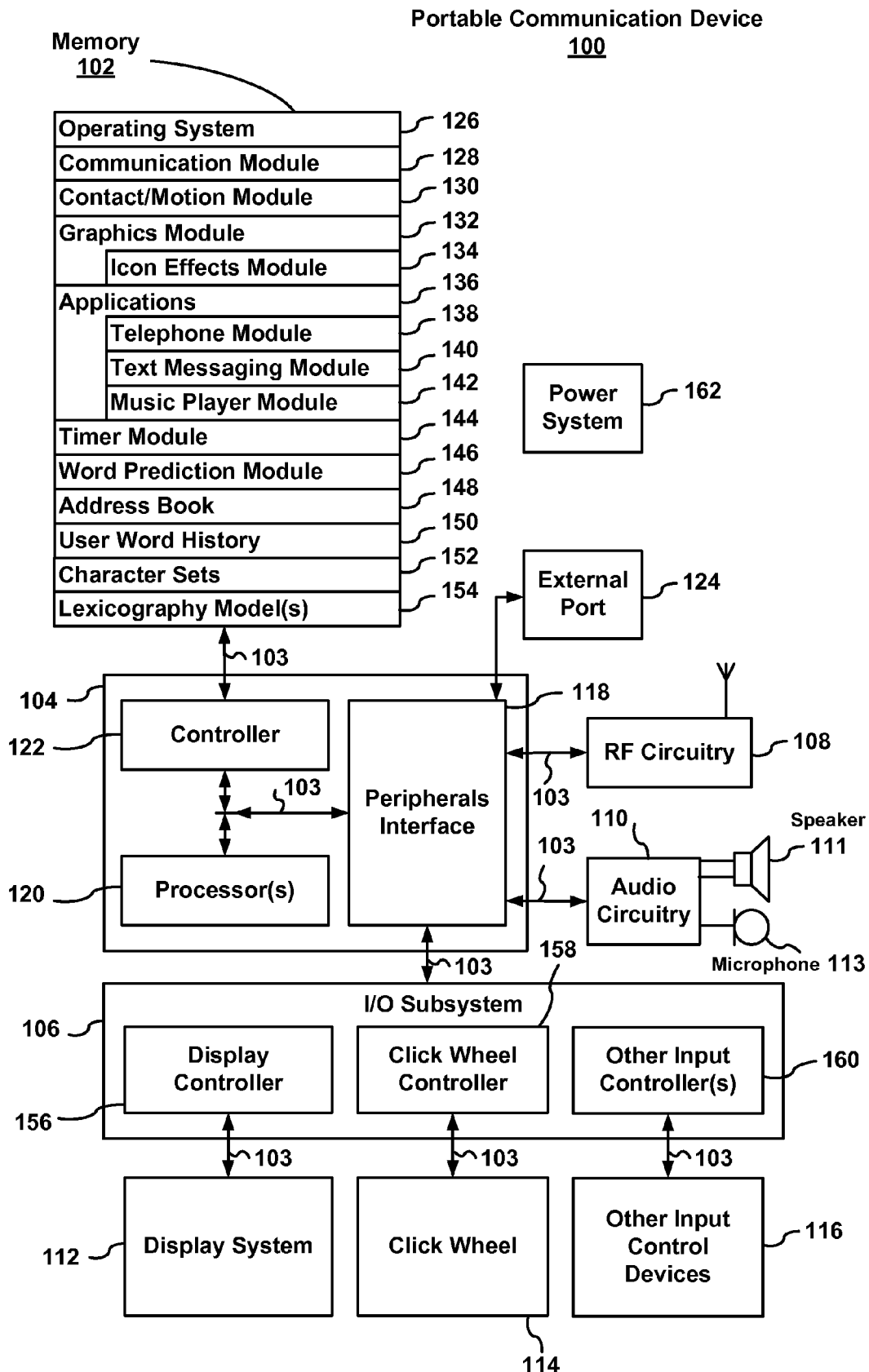

Figure 1

Portable Communication Device
300

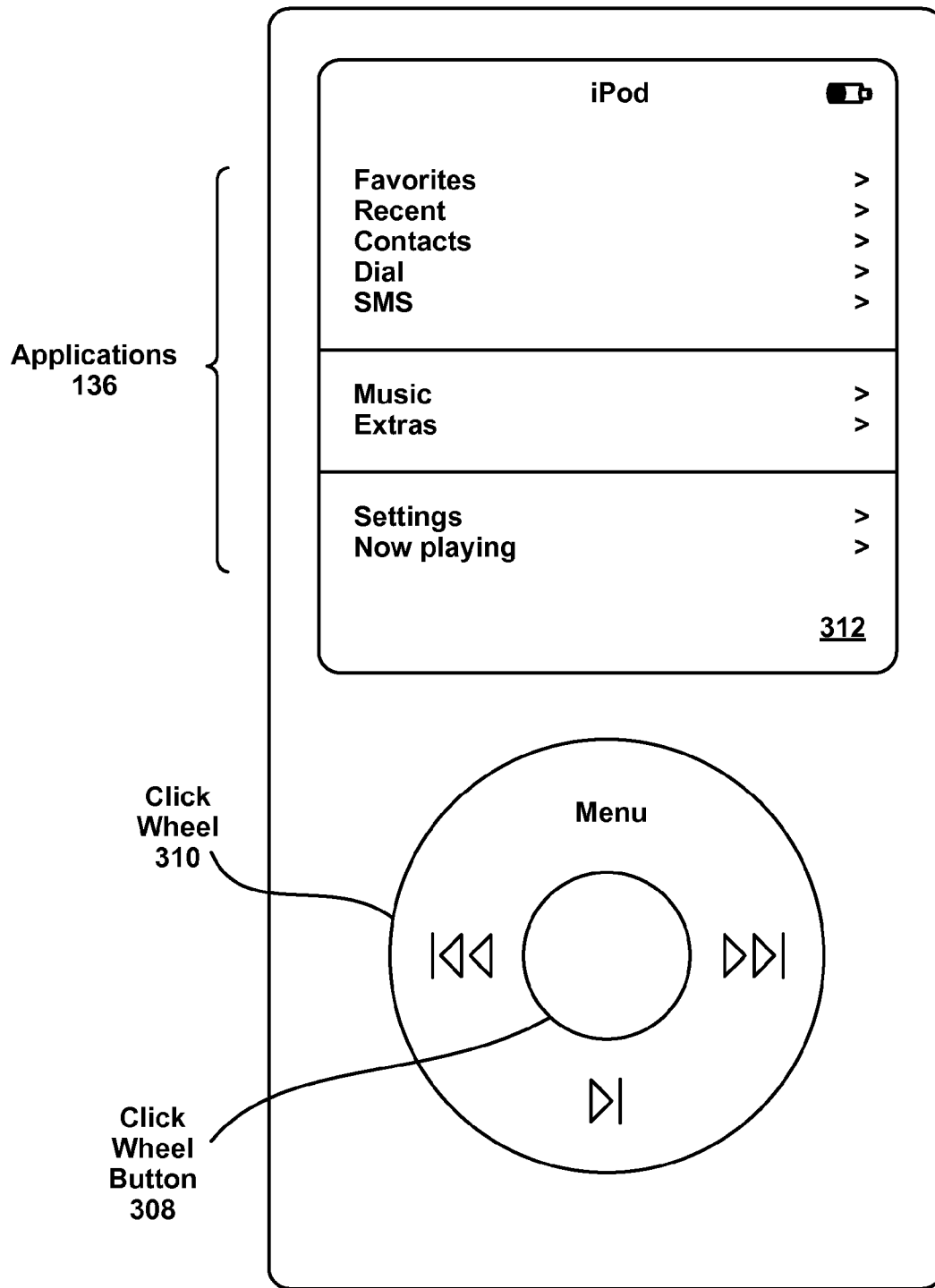

Figure 2

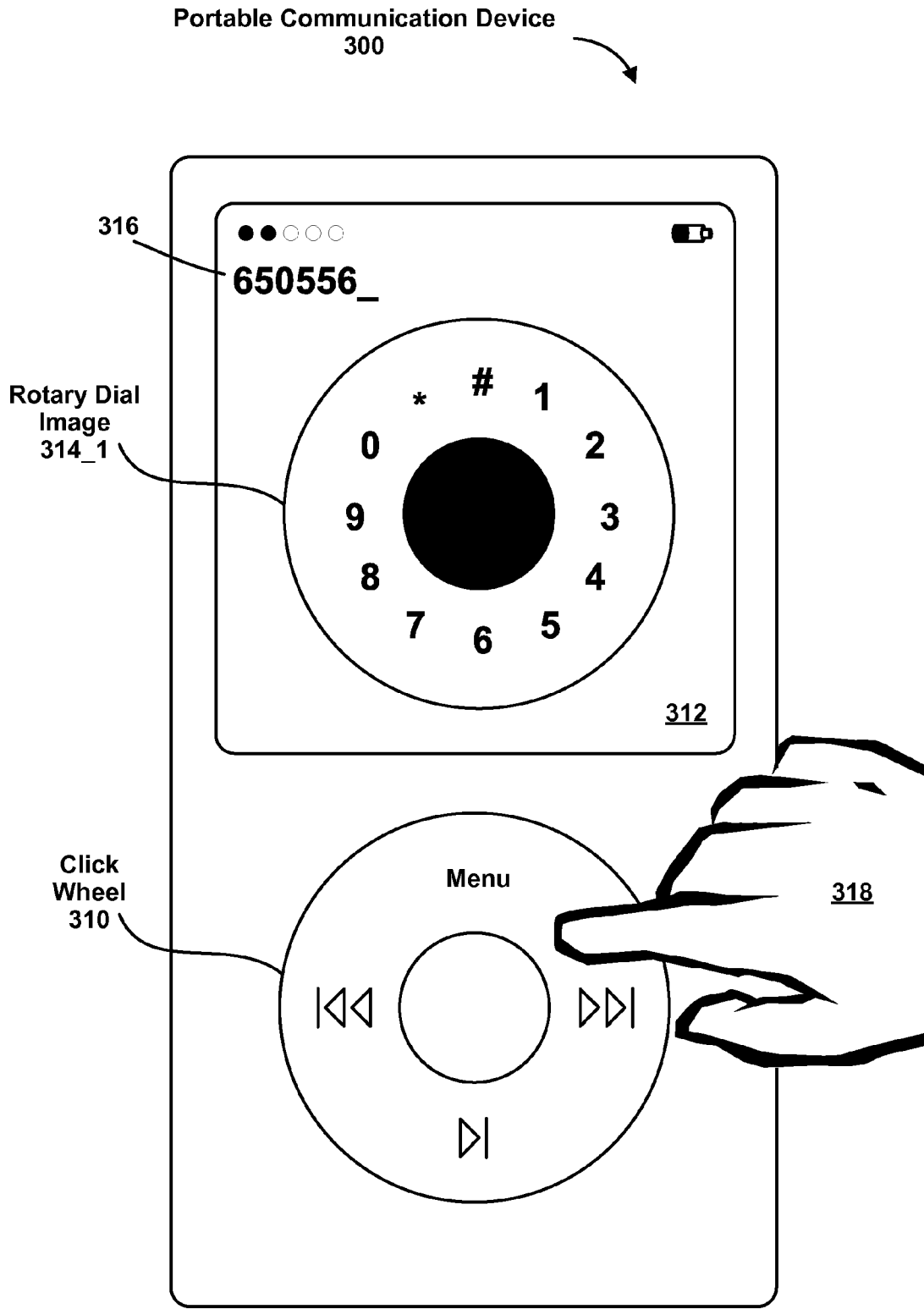

Figure 3A

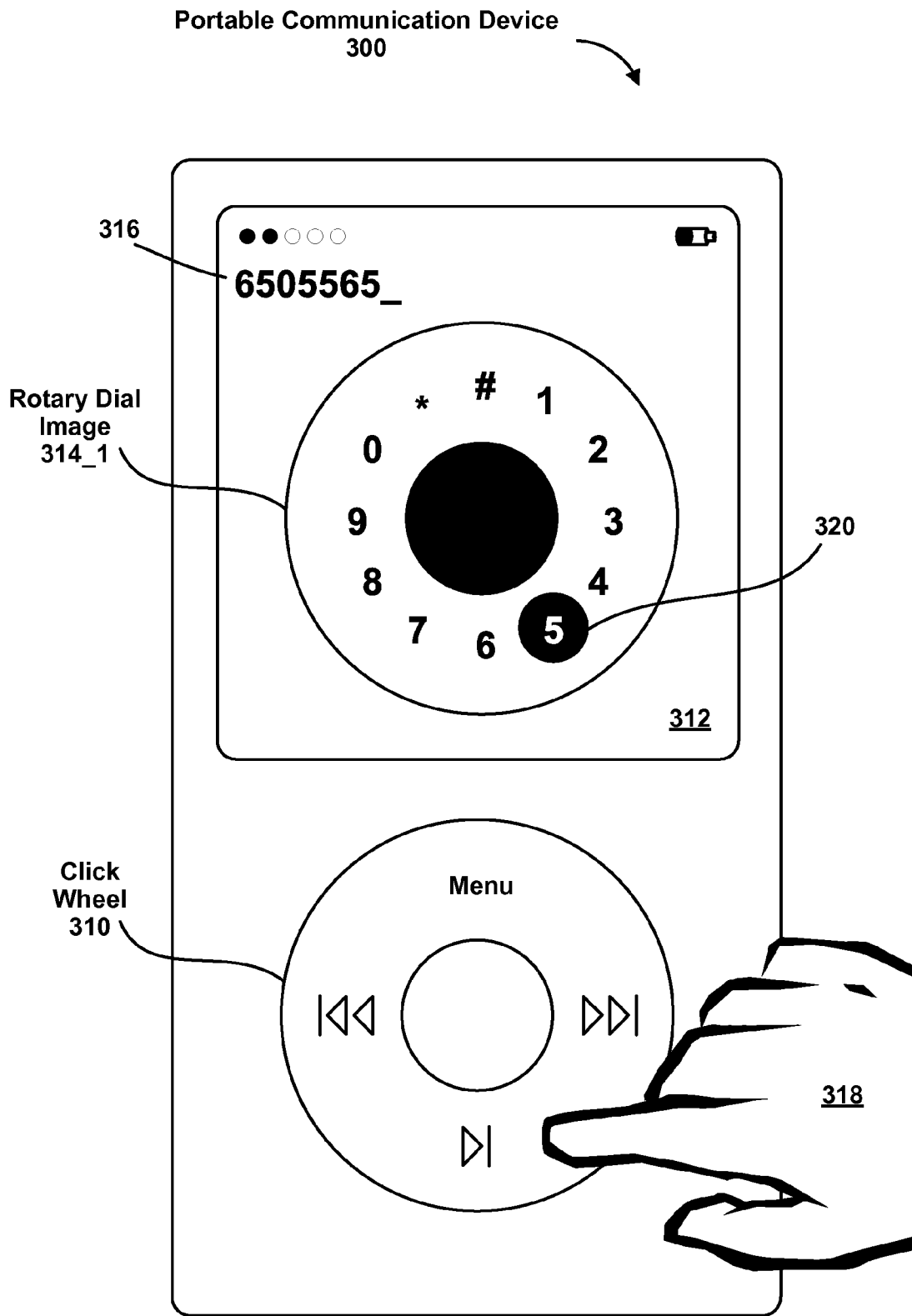

Figure 3B

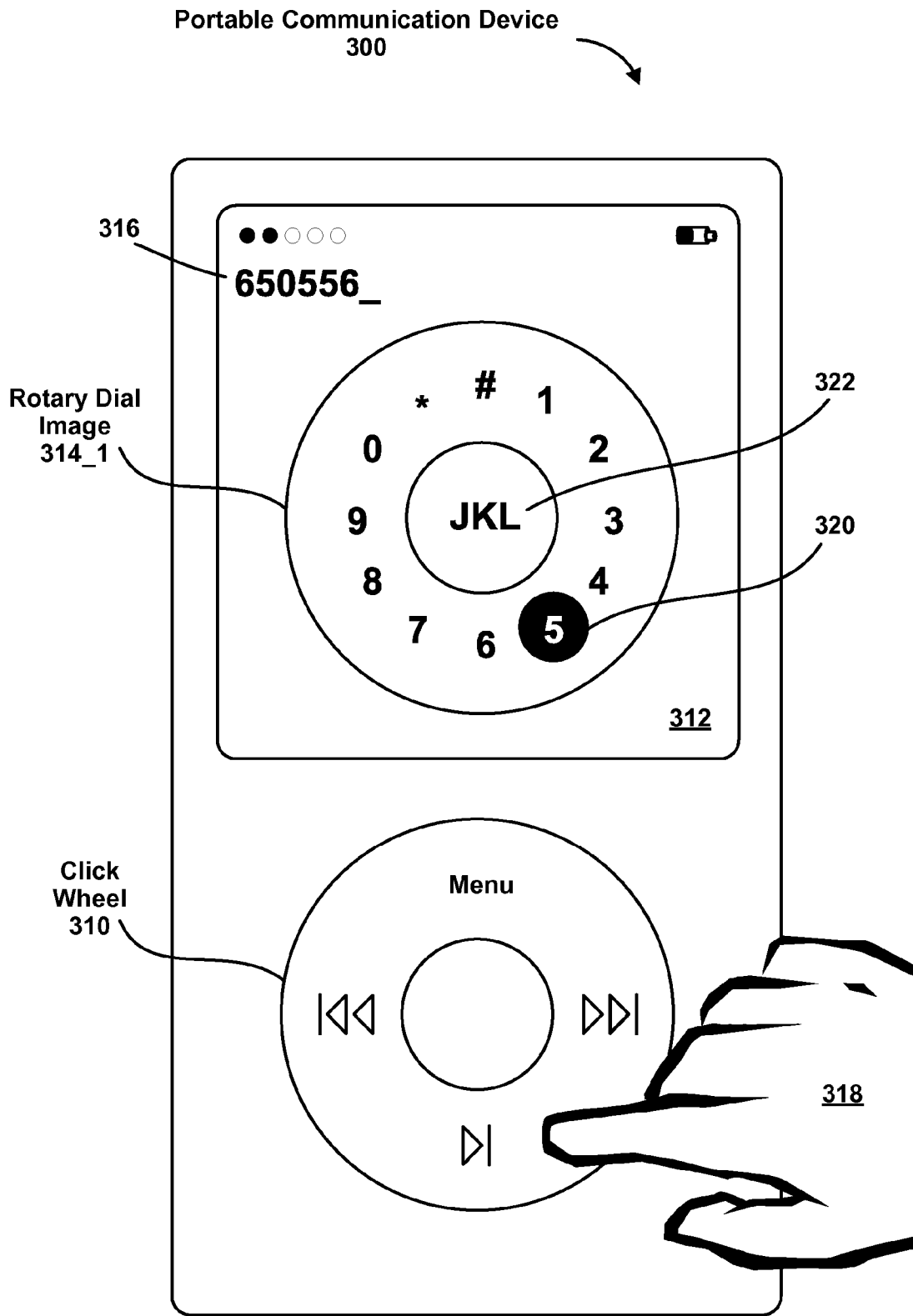

Figure 3C

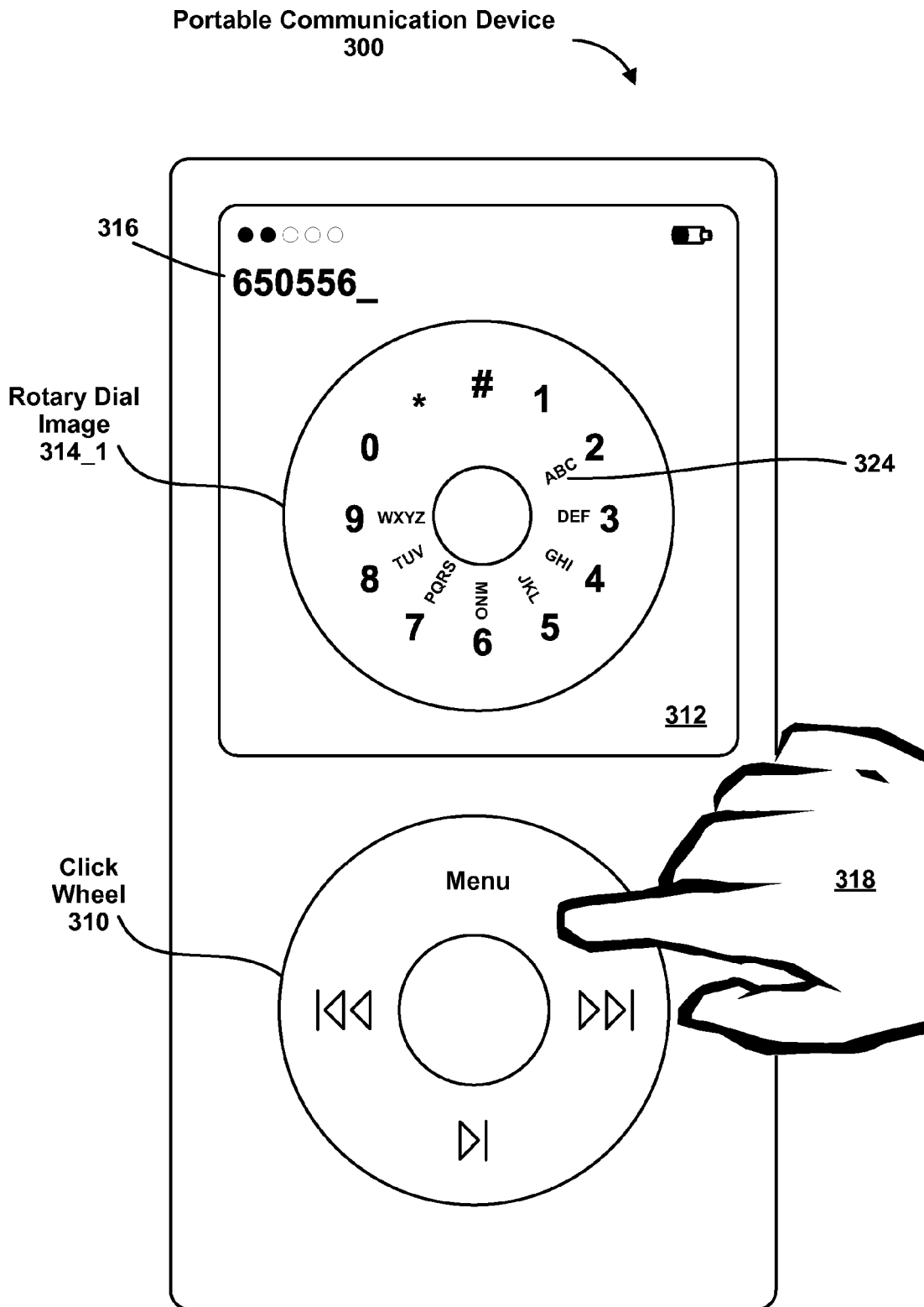

Figure 3D

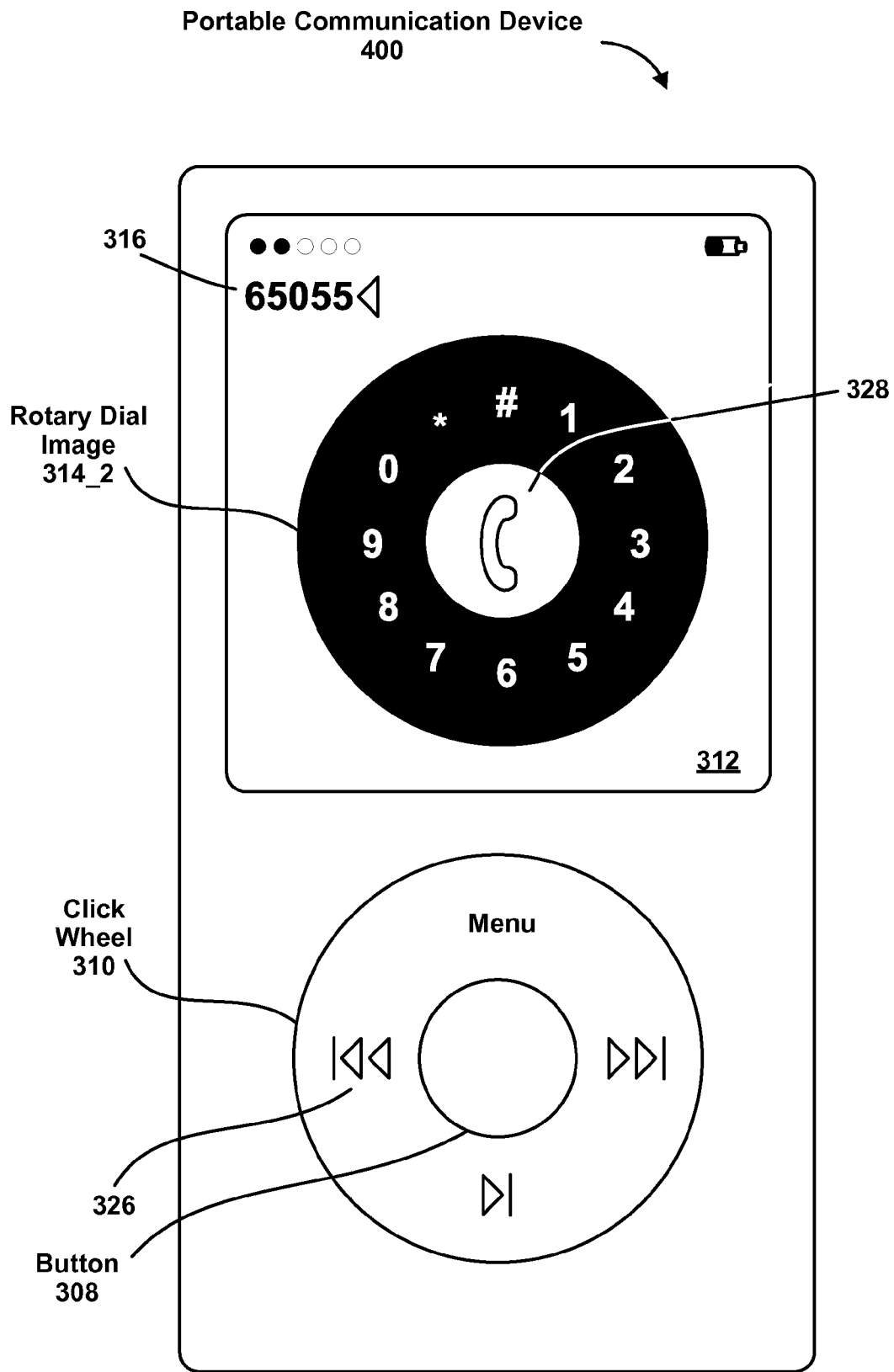

Figure 4A

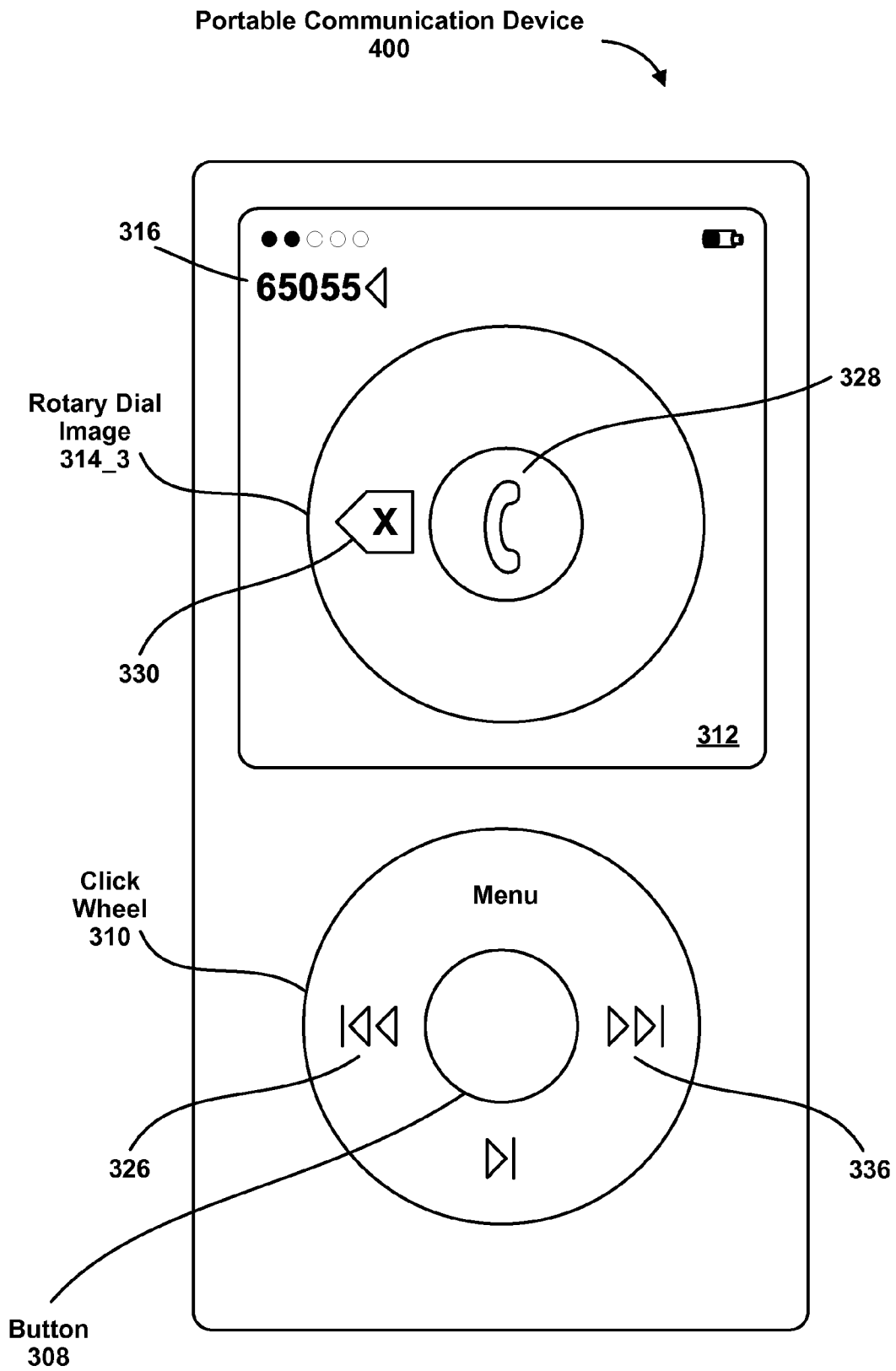

Figure 4B

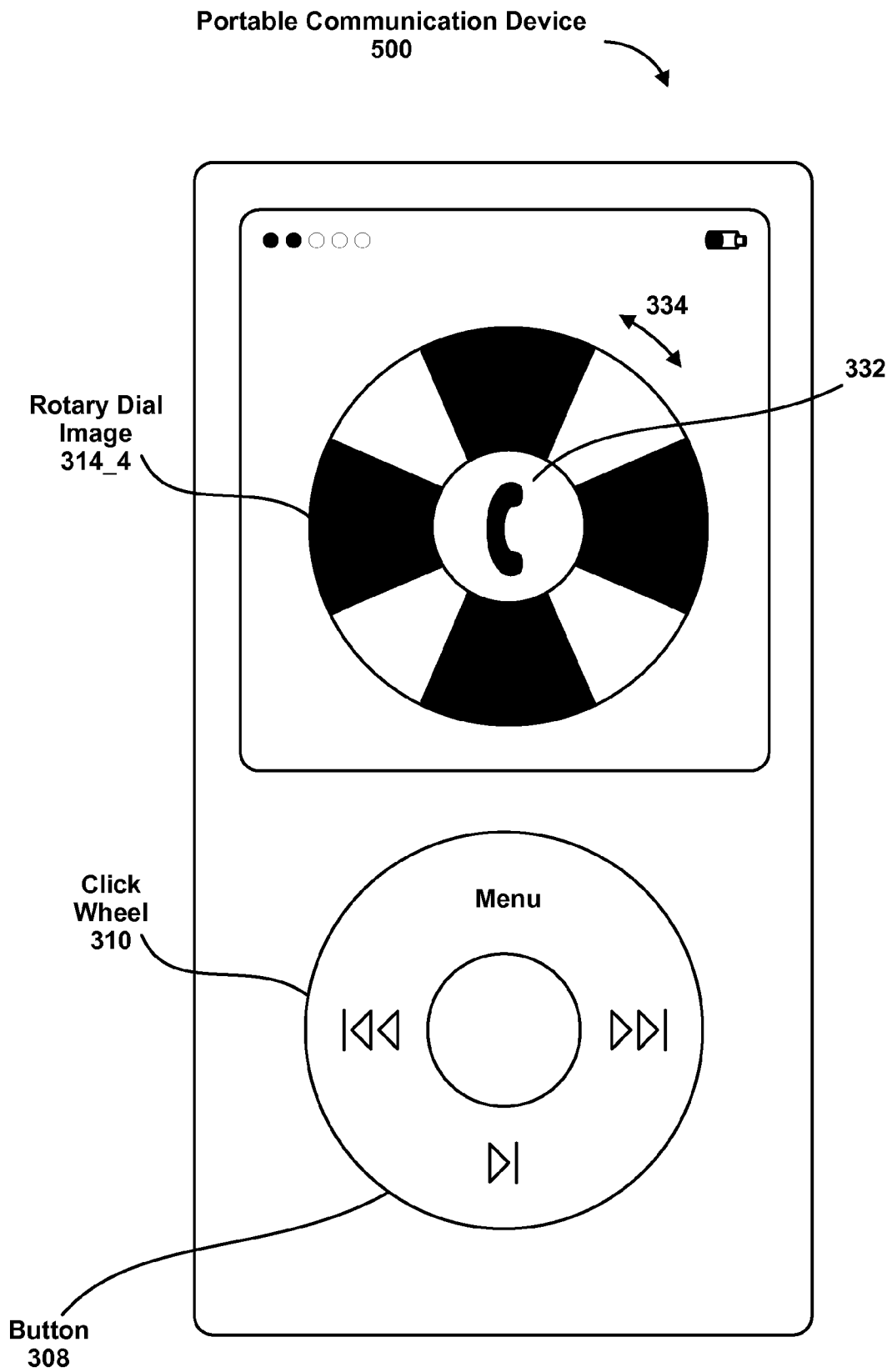

Figure 5

Telephone Number Dialing Process
600

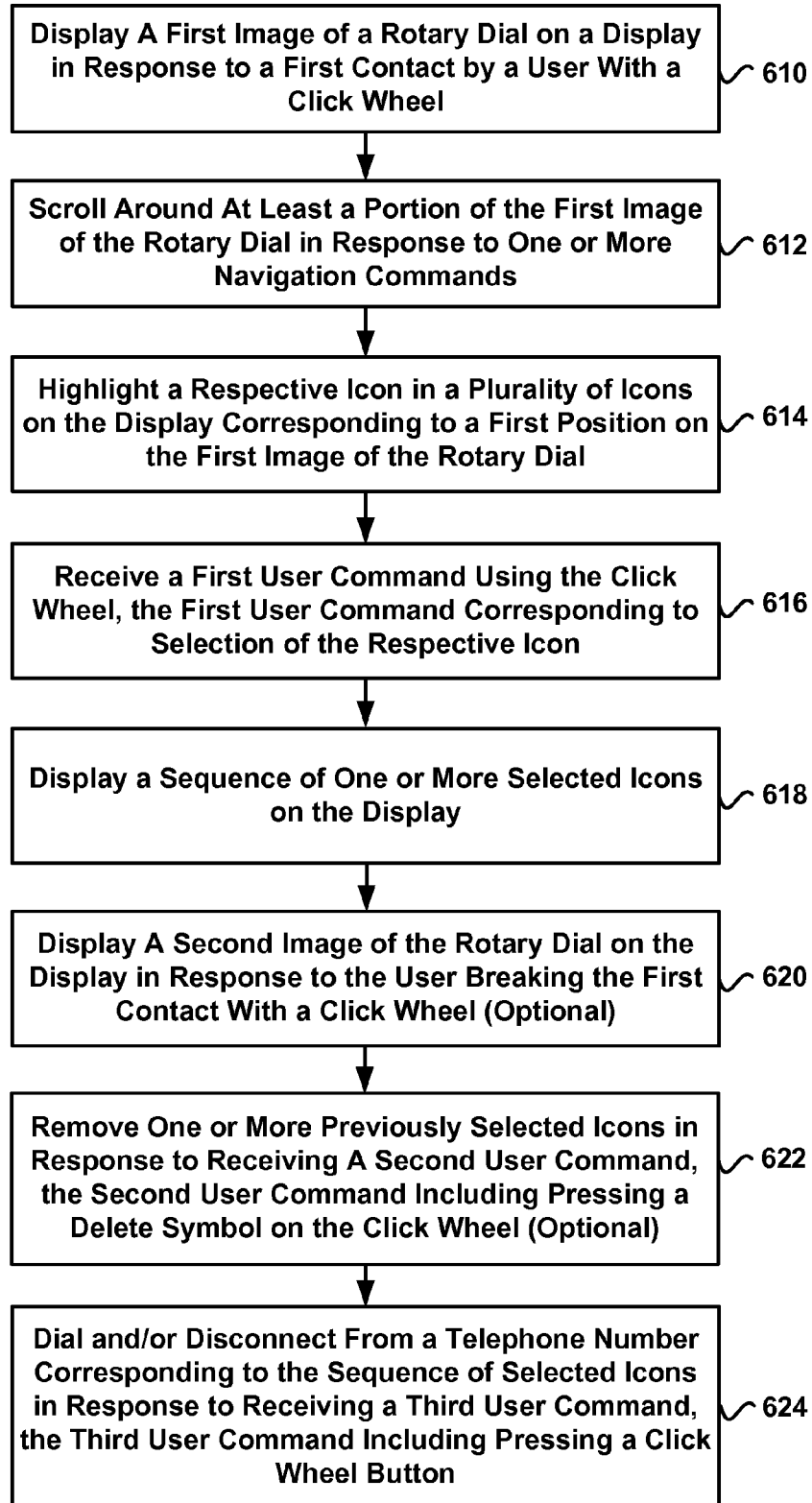

Figure 6

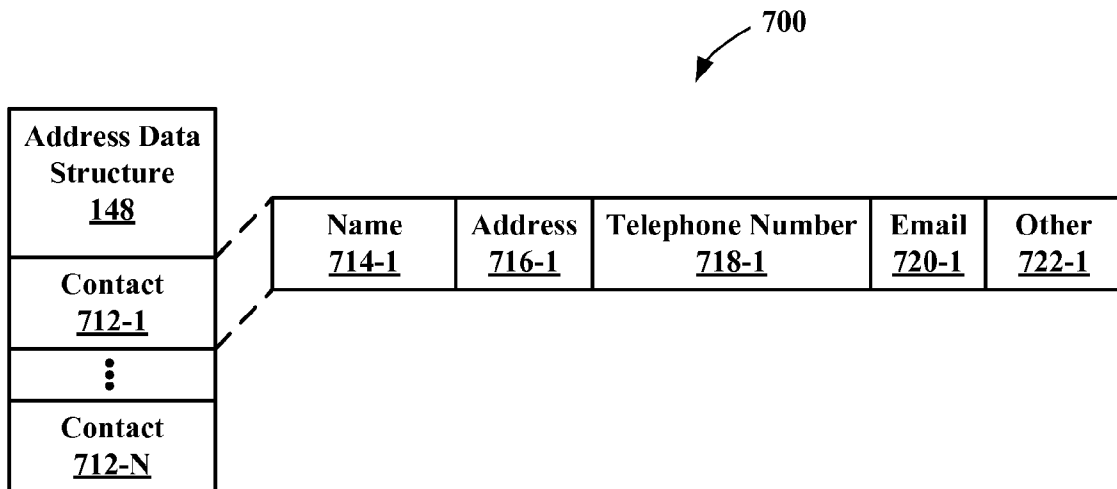

Figure 7

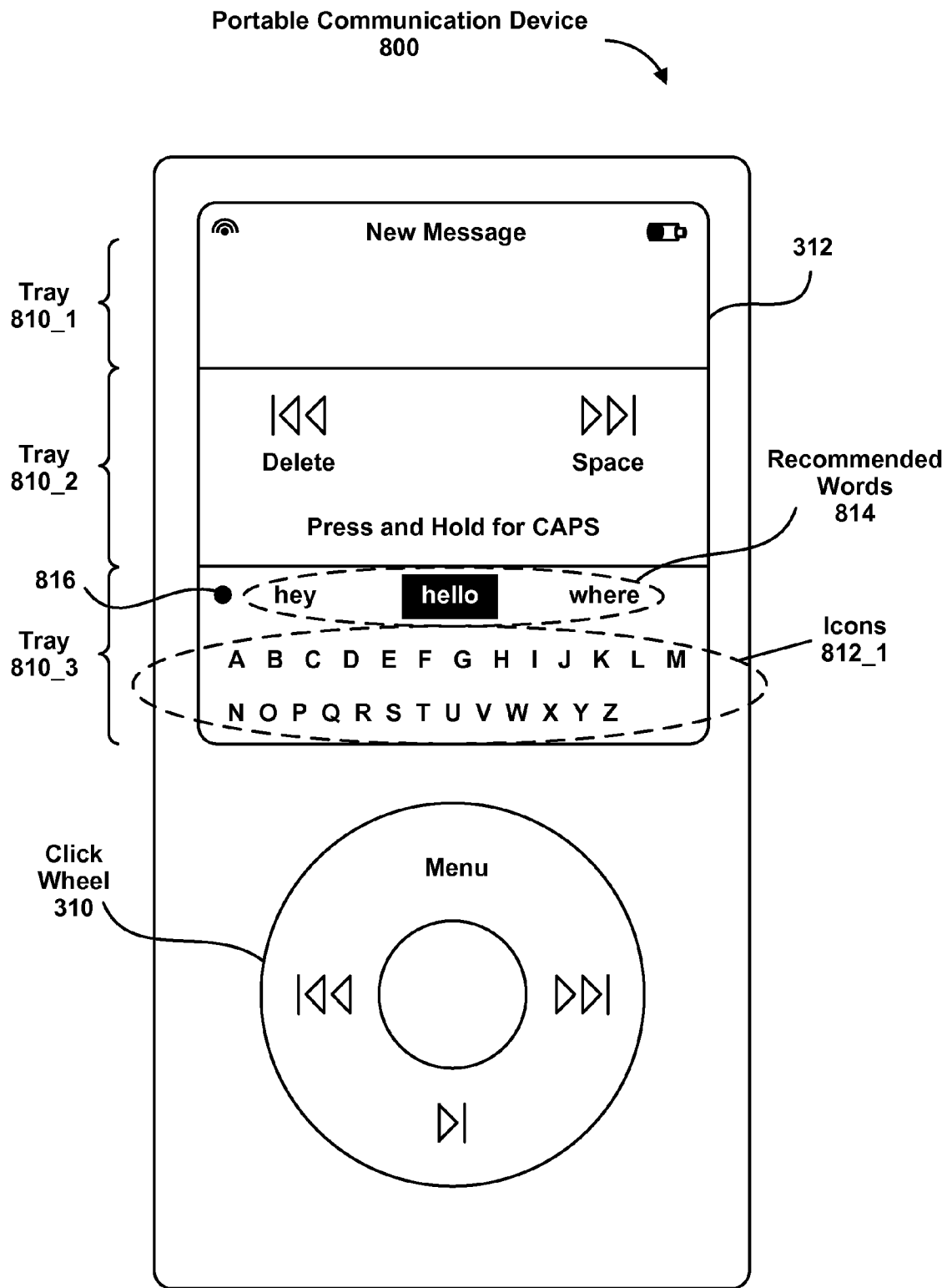

Figure 8A

Portable Communication Device
800

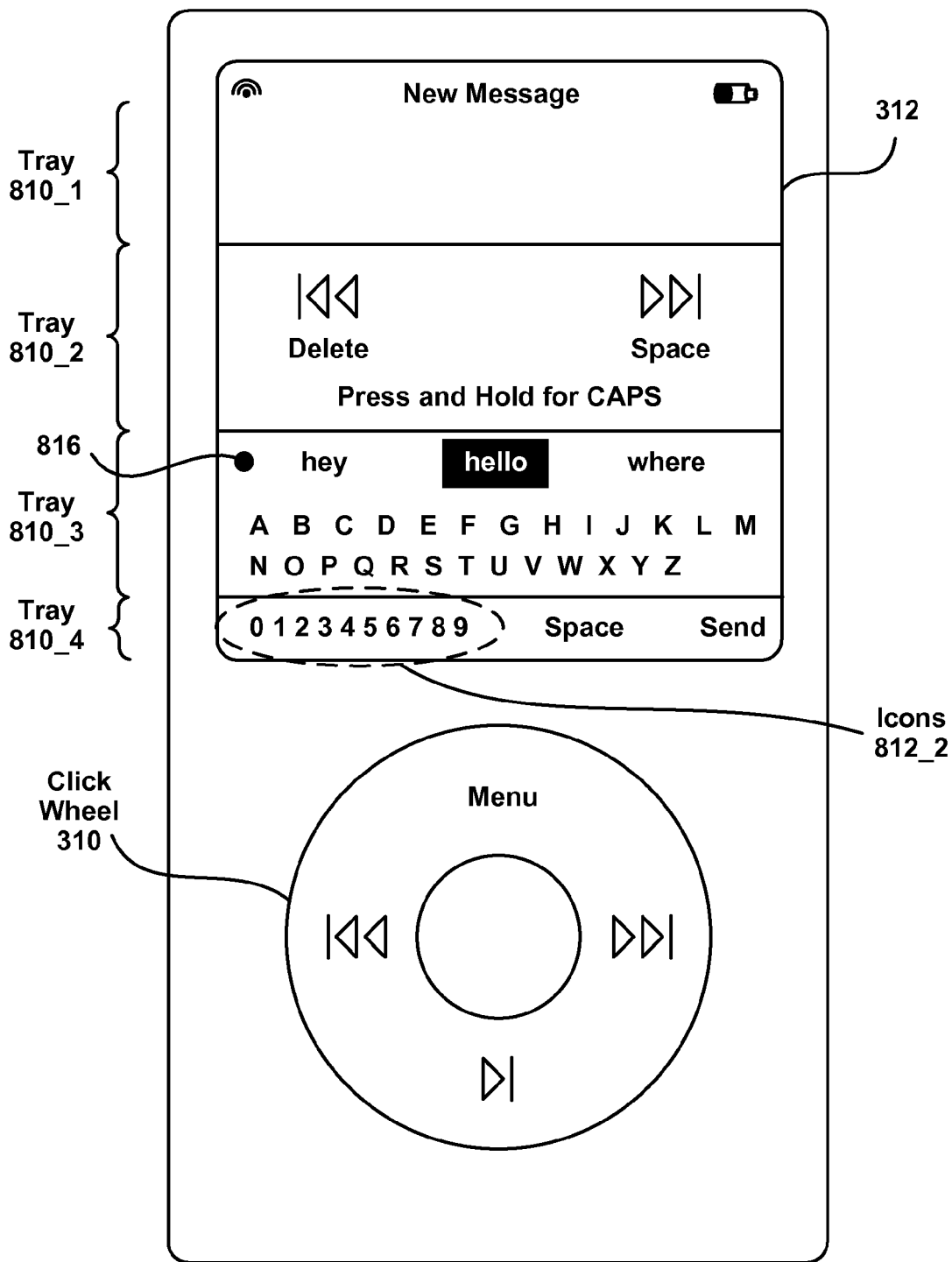

Figure 8B

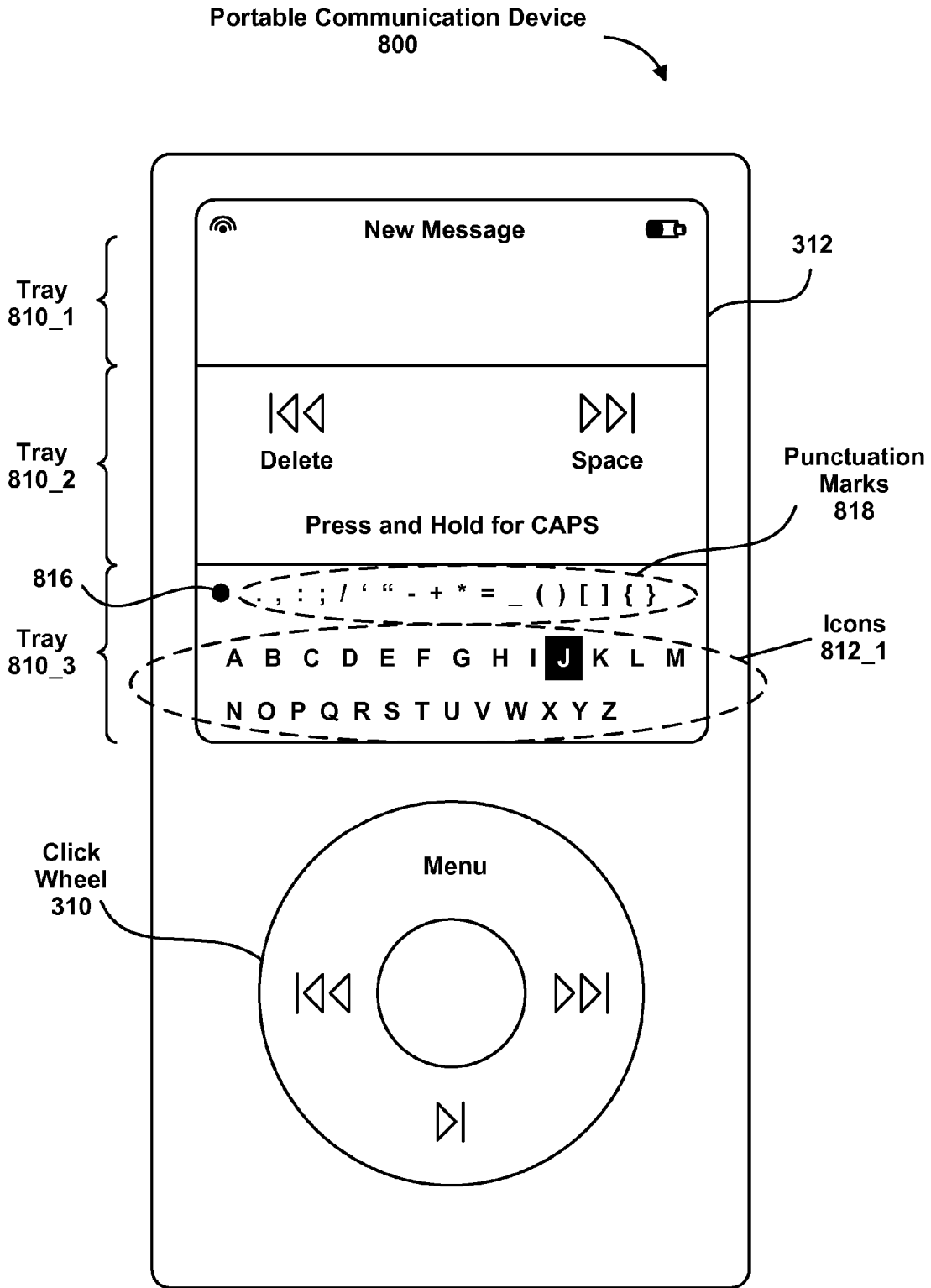

Figure 8C

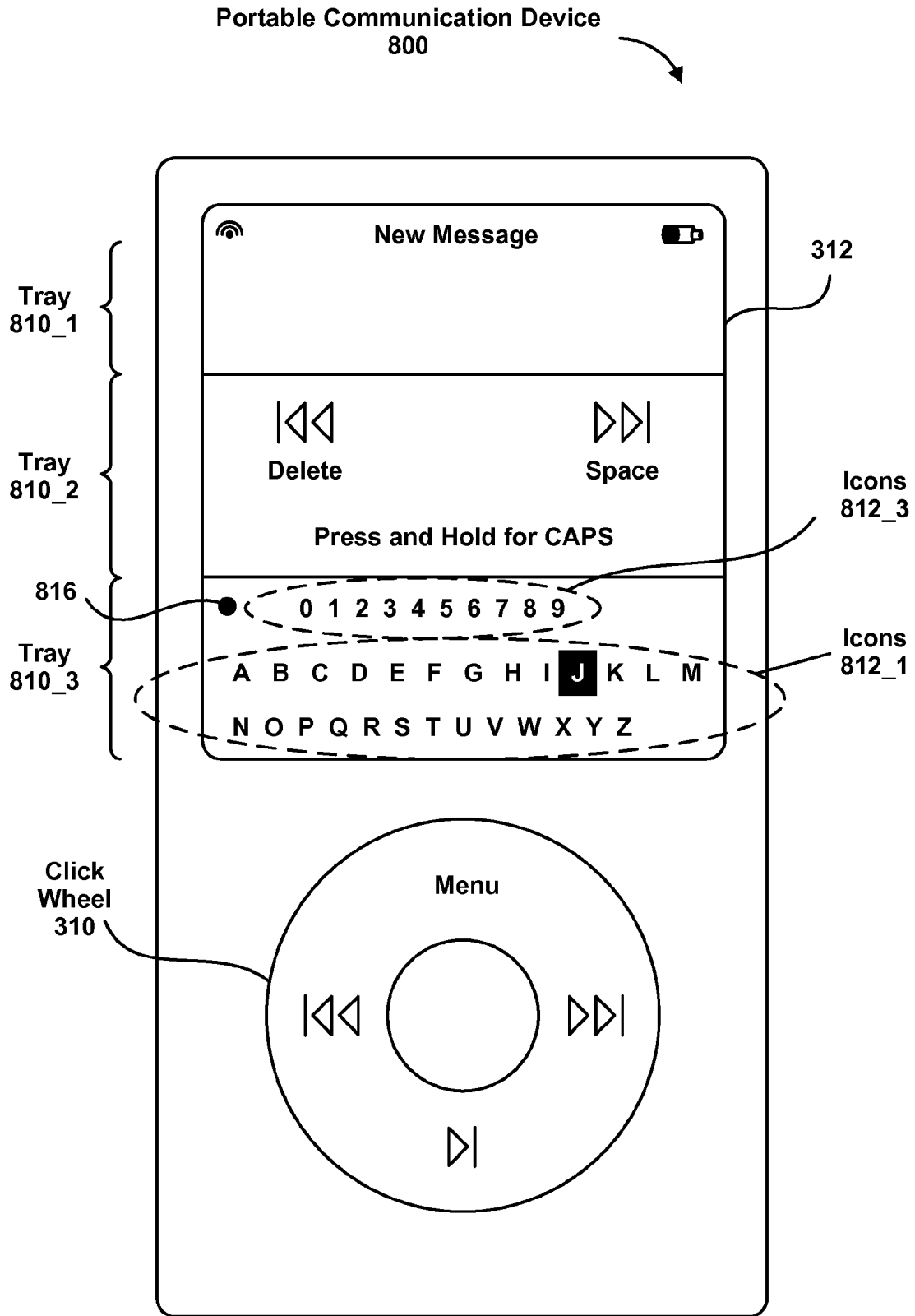

Figure 8D

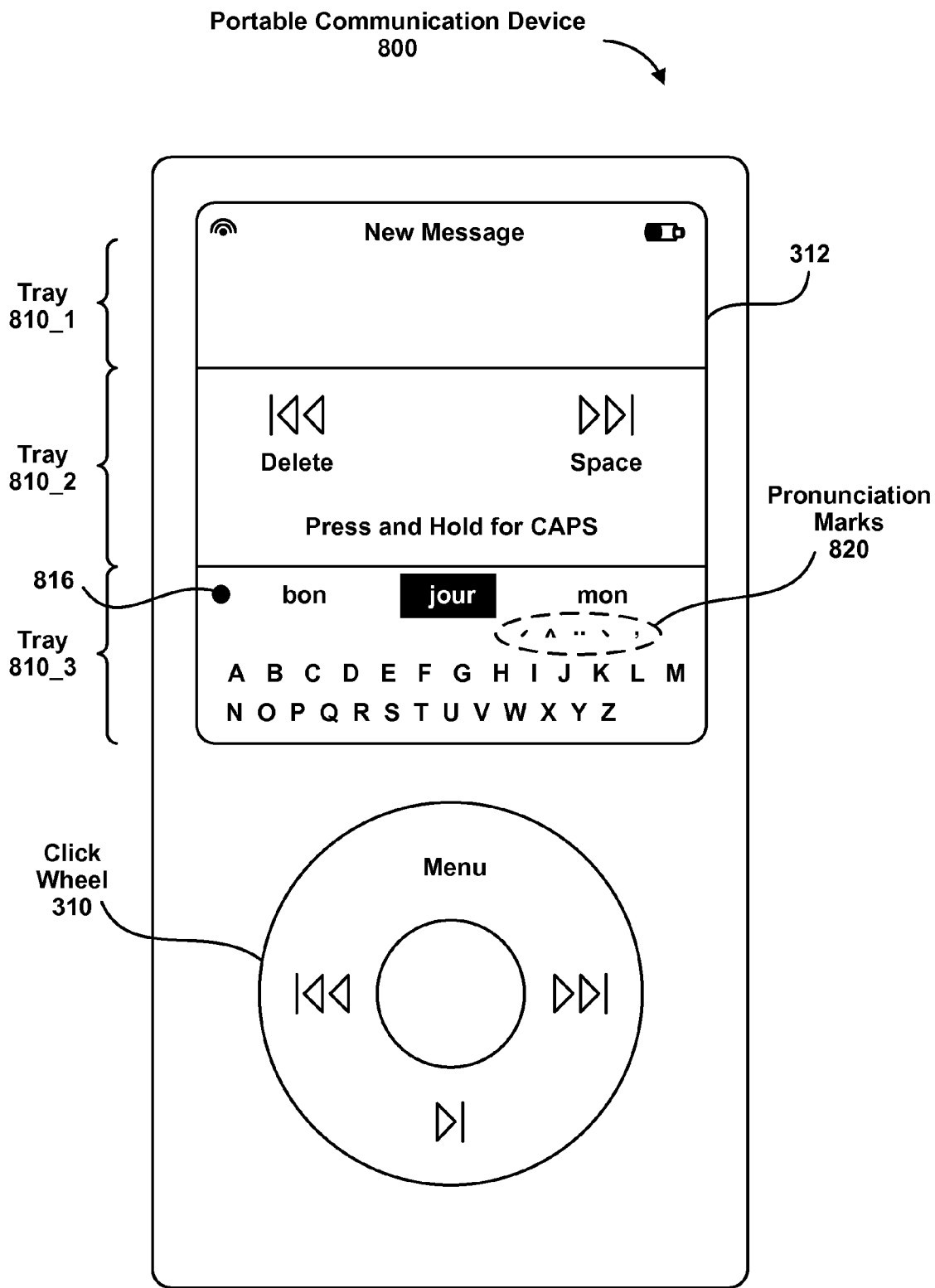

Figure 8E

Portable Communication Device
800

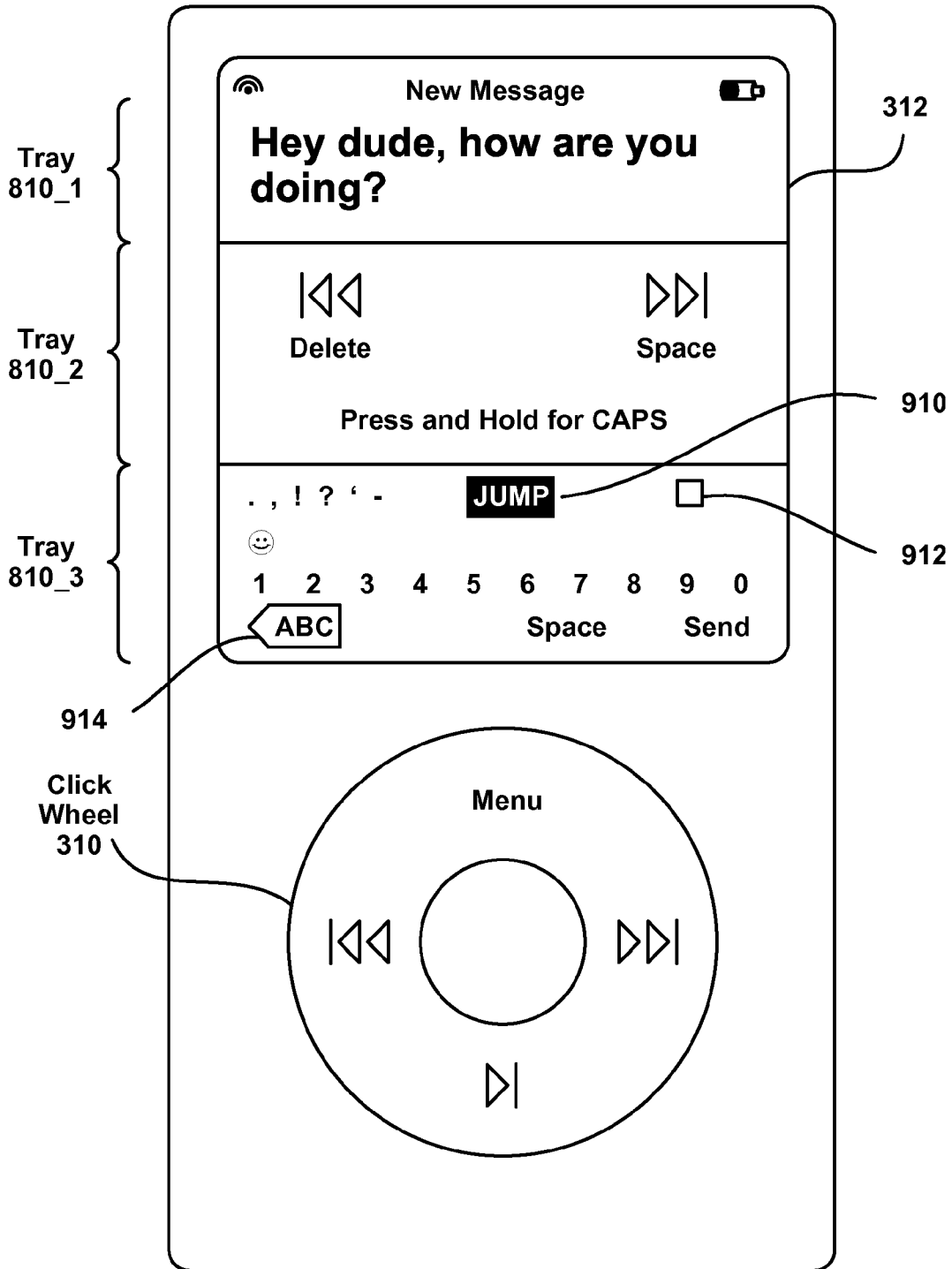

Figure 9A

Portable Communication Device
800

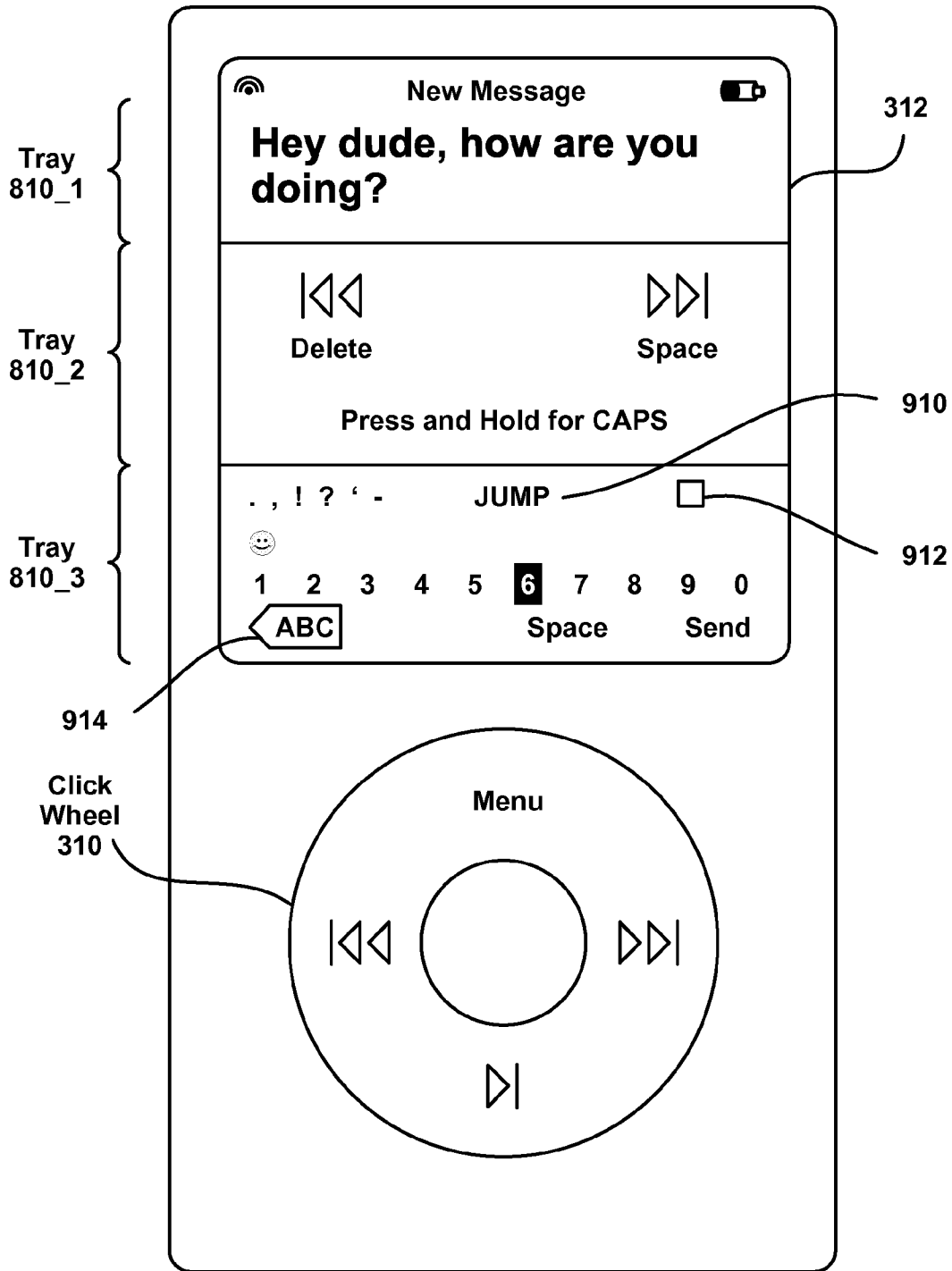

Figure 9B

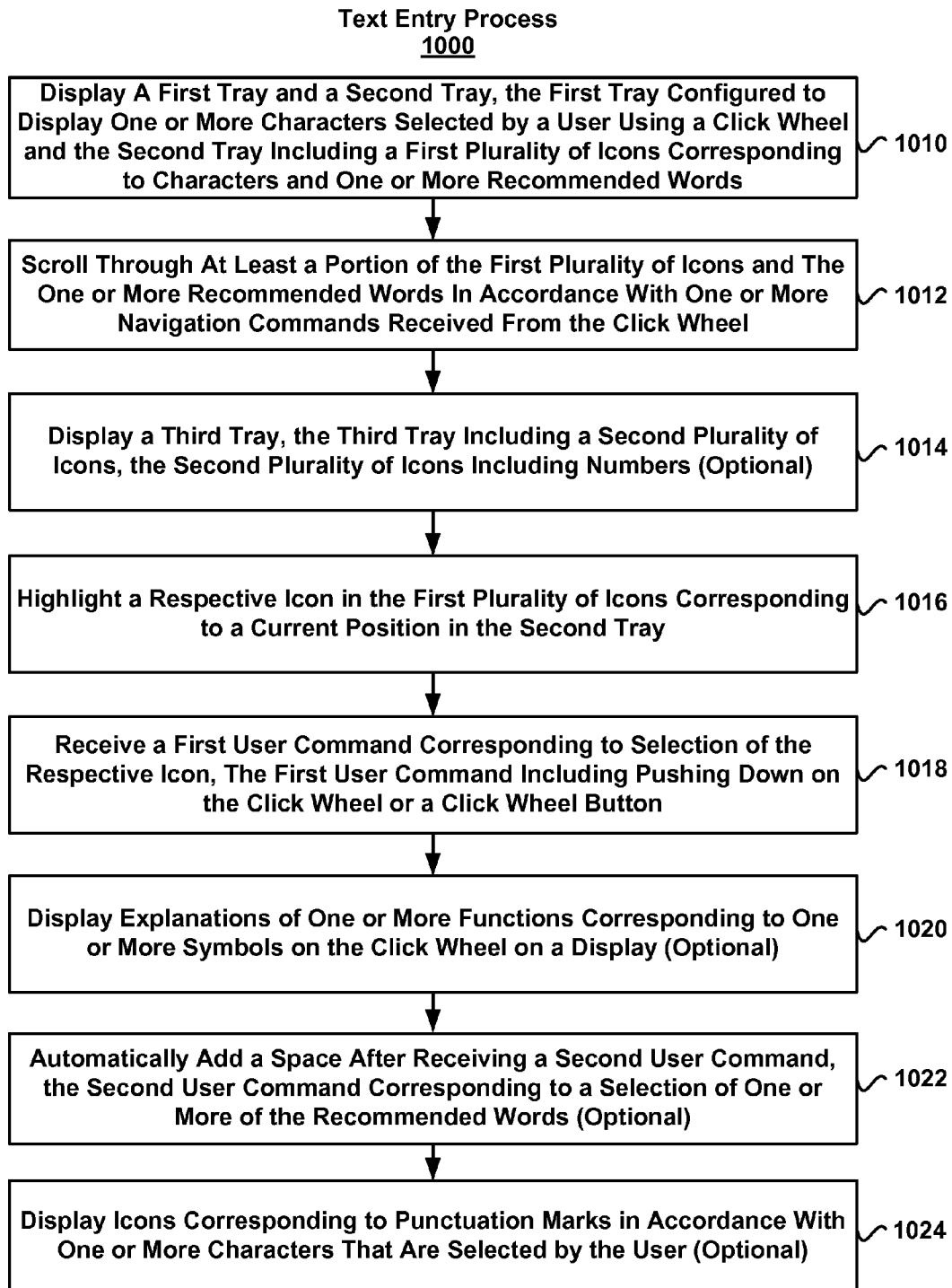

Figure 10

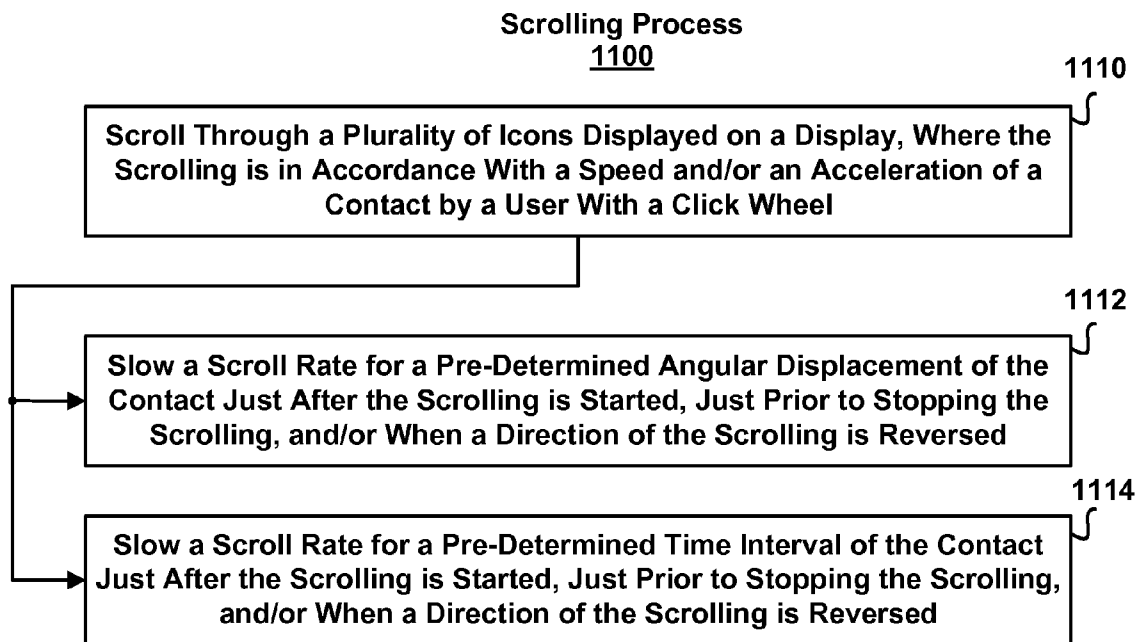

Figure 11

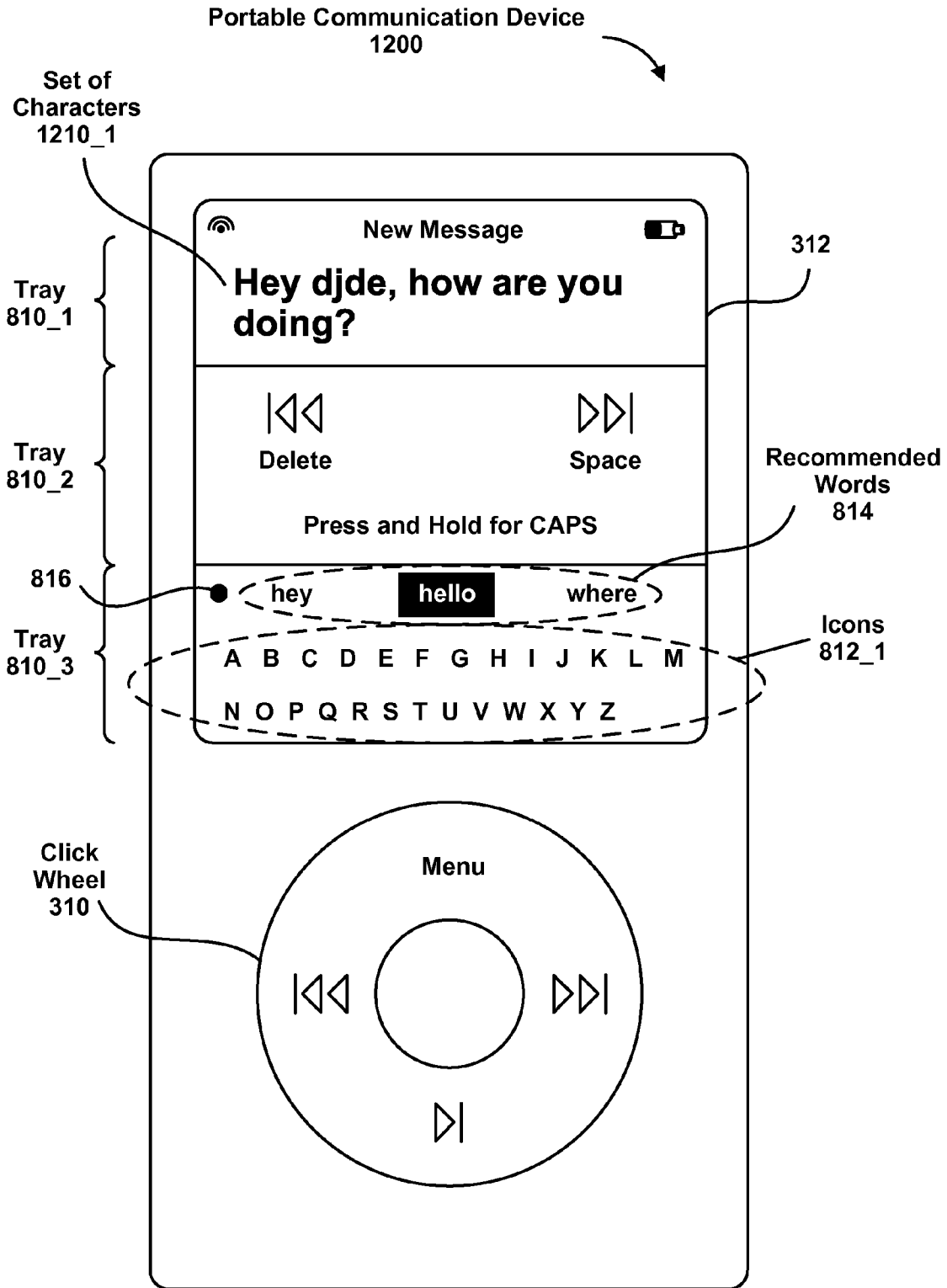

Figure 12A

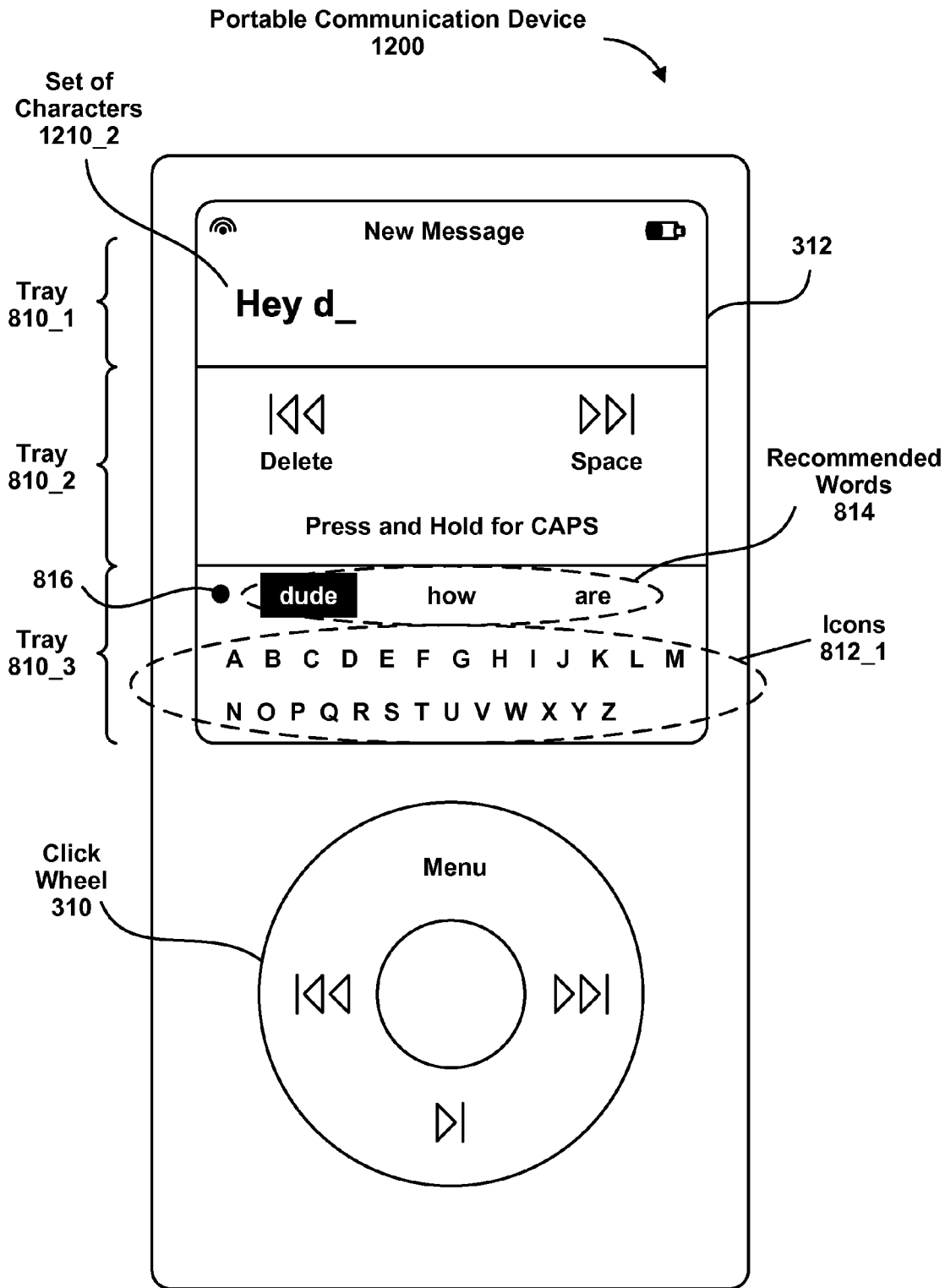

Figure 12B

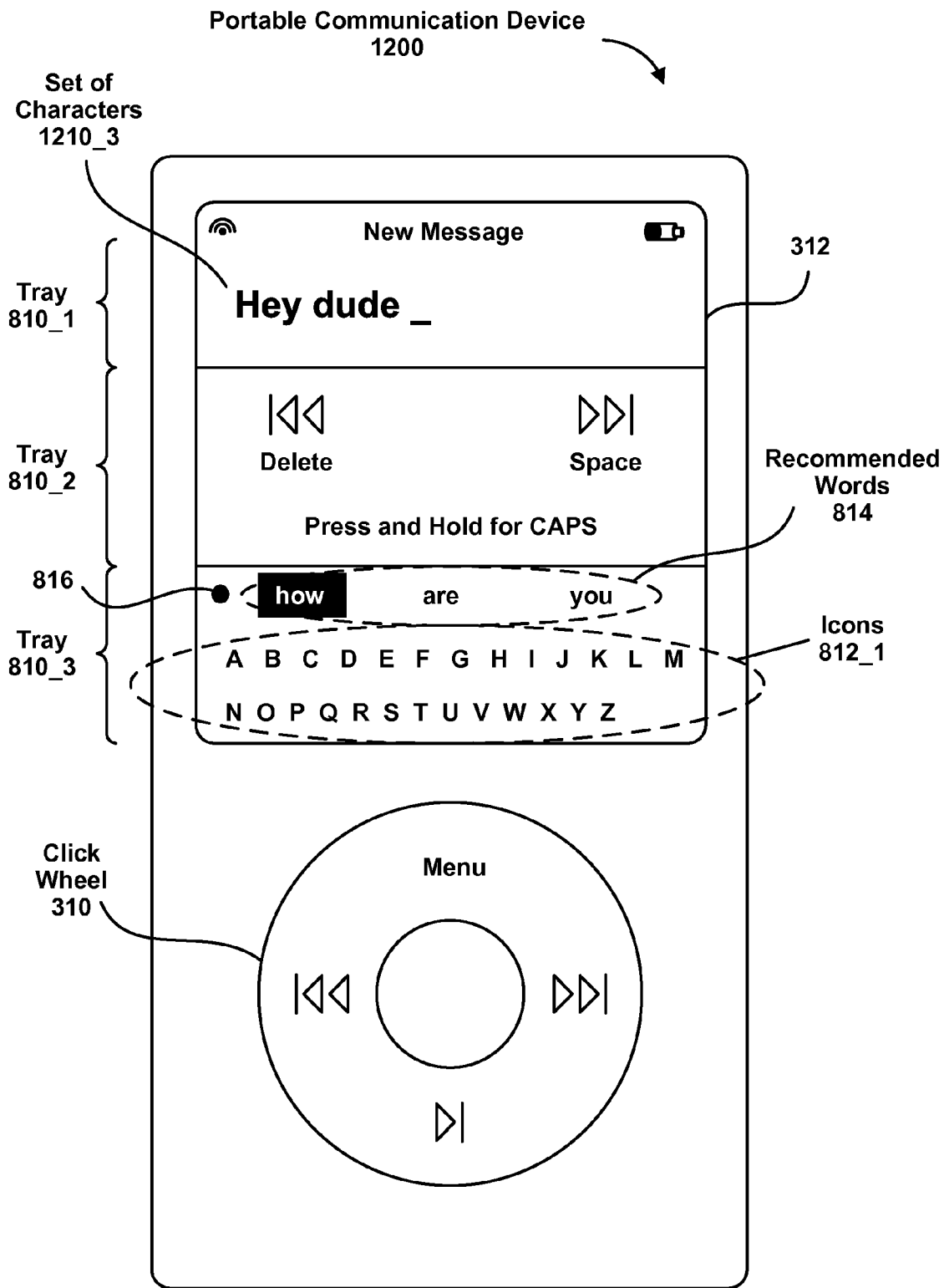

Figure 12C

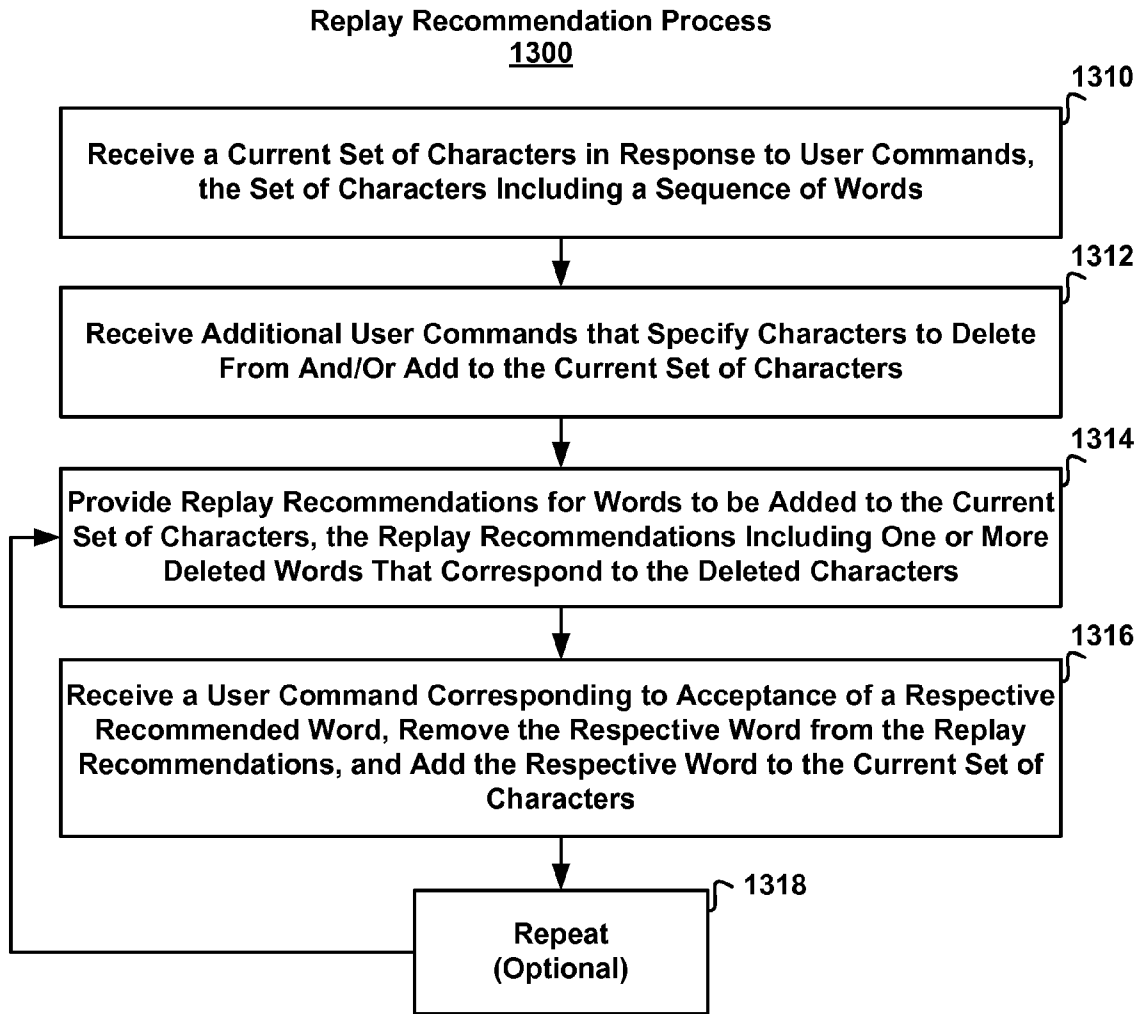

Figure 13

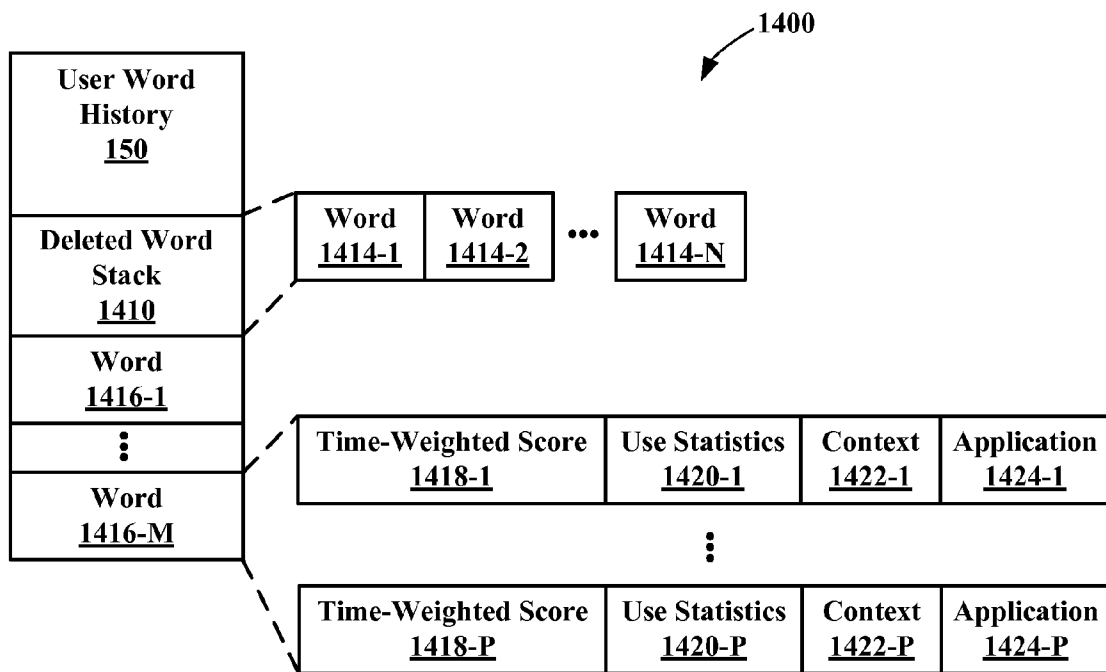

Figure 14A

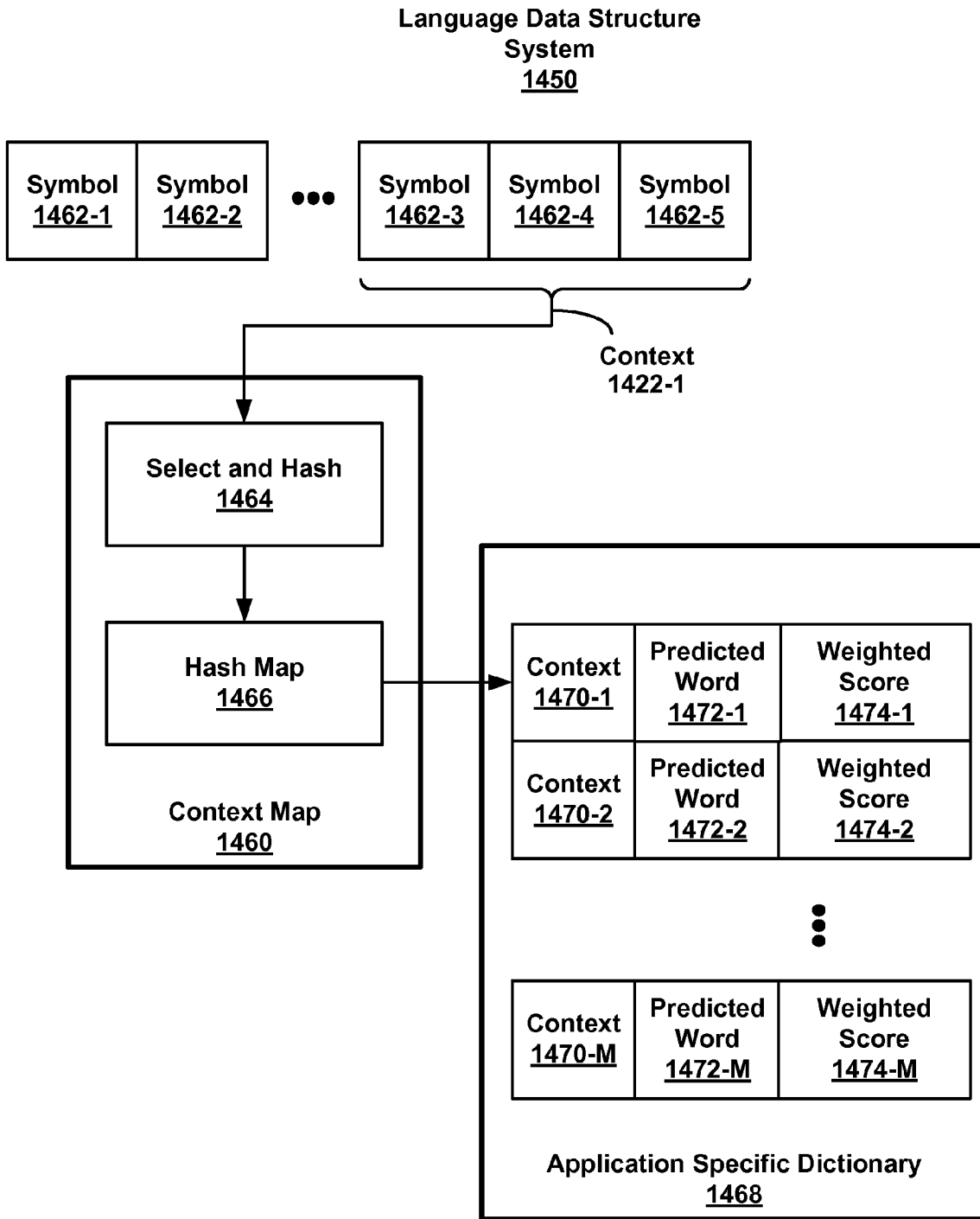

Figure 14B

TELEPHONE INTERFACE FOR A PORTABLE COMMUNICATION DEVICE

RELATED APPLICATIONS

This application claims priority to U.S. Provisional Patent Application No. 60/756,831, filed Jan. 5, 2006, entitled "Telephone Interface for Portable Communication Device," which application is incorporated by reference herein in its entirety.

This application is related to U.S. patent application Ser. No. 11/459,610, filed Jul. 24, 2006, entitled "Text Entry Interface for a Portable Communication Device," which application is incorporated by reference herein in its entirety.

This application is related to U.S. patent application Ser. No. 11/459,612, filed Jul. 24, 2006, entitled "Replay Recommendations in a Text Entry Interface," which application is incorporated by reference herein in its entirety.

TECHNICAL FIELD

The disclosed embodiments relate to user interfaces, and in particular, to telephone user interfaces that include a click wheel.

BACKGROUND

As portable devices become more compact, and the amount of information to be processed and stored increases, it has become a significant challenge to design a user interface that allows users to easily interact with the device. This is unfortunate since the user interface is the gateway through which users receive not only content but also responses to user actions or behaviors, including user attempts to access a device's features or tools. Some portable communication devices (e.g., mobile phones) have resorted to adding more pushbuttons, increasing the density of push buttons, overloading the functions of pushbuttons, or using complex menu systems to allow a user to access, store and manipulate data. These conventional user interfaces often result in complicated key sequences and menu hierarchies that must be memorized by the user. In addition, as the number of pushbuttons has increased, the proximity of neighboring buttons often makes it difficult for users to activate a desired pushbutton.

Many conventional user interfaces, such as those that include physical pushbuttons, are also inflexible. This is unfortunate because it may prevent a user interface from being configured and/or adapted by either an application running on the portable device or by users. When coupled with the time consuming requirement to memorize multiple key sequences and menu hierarchies, and the difficulty in activating a desired pushbutton, such inflexibility is frustrating to most users.

Accordingly, there is a need for more transparent and intuitive user interfaces for portable electronic devices that are easy to use, configure, and/or adapt.

SUMMARY OF EMBODIMENTS

The above deficiencies and other problems associated with user interfaces for portable devices are reduced or eliminated by the disclosed portable communication device that includes a telephone user interface.

In some embodiments, a method includes displaying a first image of a rotary dial in a display of the portable communications device in response to a first contact by a user with a

click wheel. The first image of the rotary dial includes a plurality of icons arranged proximate to a periphery of the rotary dial. The plurality of icons include numbers.

The method may include scrolling around at least a portion of the first image of the rotary dial in response to one or more navigation commands received from the click wheel. The one or more navigation commands may correspond to the user moving the first contact around at least a portion of the click wheel. A respective icon in the plurality of icons corresponding to a current position on the first image of the rotary dial may be highlighted. Explanations of one or more functions corresponding to one or more symbols on the click wheel in the display may be displayed.

The method may include receiving a first user command using the click wheel. The first user command may correspond to a selection of a respective icon in the plurality of icons. The first user command may include pushing down on the click wheel. The method may include displaying a sequence of one or more selected icons in the display.

In some embodiments, one or more letters corresponding to the respective icon are displayed along a radial direction of the first image of the rotary dial. In some embodiments, one or more letters corresponding to the respective icon are displayed in a central region of the first image of the rotary dial.

In some embodiments, the method includes displaying a second image of the rotary dial in the display of the device in response to the user breaking the first contact with the click wheel. The second image of the rotary dial has a different shading pattern than the first image of the rotary dial. The second image of the rotary dial may be displayed if the user breaks the first contact for a time interval greater than a pre-determined value. For example, the first image of the rotary dial may be faded out and the second image of the rotary dial may be faded in over a pre-determined time interval. The first image of the rotary dial may correspond to a character entry mode of operation and the second image of the rotary dial may correspond to a character correction mode of operation.

In some embodiments, the method includes removing one or more previously selected icons in response to receiving a second user command using the click wheel, wherein the second user command includes pressing on a delete symbol on the click wheel. The second image of the rotary dial may include an icon corresponding to the delete symbol on the click wheel.

In some embodiments, the method includes dialing a telephone number corresponding to the sequence of selected icons in response to receiving a third user command. The third user command may include pressing a click wheel button, such as a button at the center of the click wheel. The first image of the rotary dial may be modified in accordance with an animation sequence during the dialing. Music, such as a portion of a music file, may be played during the dialing. Volume may be adjusted during a telephone call in response to motion of a second contact by the user with the click wheel around at least a portion of the click wheel.

In some embodiments, the method includes disconnecting from the dialed telephone number in response to receiving a fourth user command. The fourth user command may include pressing the button at the center of the click wheel.

The aforementioned methods may be performed by a portable electronic device having a touch-sensitive display with a graphical user interface (GUI), one or more processors, memory and one or more modules, programs or sets of instructions stored in the memory for performing these meth-

ods. In some embodiments, the portable electronic device provides a plurality of functions, including wireless communication.

Instructions for performing the aforementioned methods may be included in a computer program product configured for execution by one or more processors.

BRIEF DESCRIPTION OF THE DRAWINGS

For a better understanding of the aforementioned embodiments of the invention as well as additional embodiments thereof, reference should be made to the Description of Embodiments below, in conjunction with the following drawings in which like reference numerals refer to corresponding parts throughout the figures.

FIG. 1 is a block diagram illustrating an embodiment of an architecture for a portable communication device.

FIG. 2 is a schematic diagram illustrating an embodiment of a user interface for a portable communication device.

FIG. 3A is a schematic diagram illustrating an embodiment of a telephone user interface for a portable communication device.

FIG. 3B is a schematic diagram illustrating an embodiment of a telephone user interface for a portable communication device.

FIG. 3C is a schematic diagram illustrating an embodiment of a telephone user interface for a portable communication device.

FIG. 3D is a schematic diagram illustrating an embodiment of a telephone user interface for a portable communication device.

FIG. 4A is a schematic diagram illustrating an embodiment of a telephone user interface for a portable communication device.

FIG. 4B is a schematic diagram illustrating an embodiment of a telephone user interface for a portable communication device.

FIG. 5 is a schematic diagram illustrating an embodiment of a telephone user interface for a portable communication device.

FIG. 6 is a flow diagram of an embodiment of a telephone number dialing process.

FIG. 7 is a block diagram illustrating an embodiment of an address book data structure.

FIG. 8A is a schematic diagram illustrating an embodiment of a text entry user interface for a portable communication device.

FIG. 8B is a schematic diagram illustrating an embodiment of a text entry user interface for a portable communication device.

FIG. 8C is a schematic diagram illustrating an embodiment of a text entry user interface for a portable communication device.

FIG. 8D is a schematic diagram illustrating an embodiment of a text entry user interface for a portable communication device.

FIG. 8E is a schematic diagram illustrating an embodiment of a text entry user interface for a portable communication device.

FIG. 9A is a schematic diagram illustrating an embodiment of a text entry user interface for a portable communication device.

FIG. 9B is a schematic diagram illustrating an embodiment of a text entry user interface for a portable communication device.

FIG. 10 is a flow diagram of an embodiment of a text entry process.

FIG. 11 is a flow diagram of an embodiment of a scrolling process.

FIG. 12A is a schematic diagram illustrating an embodiment of replay recommendations in a user interface for a portable communication device.

FIG. 12B is a schematic diagram illustrating an embodiment of replay recommendations in a user interface for a portable communication device.

FIG. 12C is a schematic diagram illustrating an embodiment of replay recommendations in a user interface for a portable communication device.

FIG. 13 is a flow diagram of an embodiment of a replay recommendation process.

FIG. 14A is a block diagram illustrating an embodiment of a user word history data structure.

FIG. 14B is a block diagram illustrating an embodiment of a language data structure system.

DESCRIPTION OF EMBODIMENTS

Reference will now be made in detail to embodiments, examples of which are illustrated in the accompanying drawings. In the following detailed description, numerous specific details are set forth in order to provide a thorough understanding of the present invention. However, it will be apparent to one of ordinary skill in the art that the present invention may be practiced without these specific details. In other instances, well-known methods, procedures, components, and circuits have not been described in detail so as not to unnecessarily obscure aspects of the embodiments.

Embodiments of user interfaces and associated processes for using a device are described. In some embodiments, the device may be a portable communications device. The user interface may include a click wheel and/or touch screen. A click wheel is a physical user-interface device that may provide navigation commands based on an angular displacement of the wheel or a point of contact with the wheel by a user of the device. A click wheel may also be used to provide a user command corresponding to selection of one or more items, for example, when the user of the device presses down on at least a portion of the wheel. For simplicity, in the discussion that follows, a portable communications device (e.g., a cellular telephone that may also contain other functions, such as PDA and music player functions) that includes a click wheel is used as an exemplary embodiment. It should be understood, however, that the user interfaces and associated processes may be applied to other devices, such as personal computers and laptops, that may include one or more other physical user-interface devices, such as a keyboard, a mouse and/or a joystick.

The device may support a variety of applications, such as a telephone, text messaging and a music player. The music player may be compatible with one or more file formats, such as MP3 and/or AAC. In an exemplary embodiment, the device includes an iPod music player (trademark of Apple Computer, Inc.).

The various applications that may be executed on the device may use at least one common physical user-interface device, such as the click wheel. One or more functions of the click wheel as well as corresponding information displayed on the device may be adjusted and/or varied from one application to the next and/or within a respective application. In this way, a common physical architecture (such as the click wheel) of the device may support the variety of applications with user interfaces that are intuitive and transparent.

Attention is now directed towards embodiments of the device. FIG. 1 is a block diagram illustrating an architecture

for a portable communication device **100**, according to some embodiments of the invention. The device **100** may include a memory **102** (which may include one or more computer readable storage mediums), a memory controller **122**, one or more processing units (CPU's) **120**, a peripherals interface **118**, RF circuitry **108**, audio circuitry **110**, a speaker **111**, a microphone **113**, an input/output (I/O) subsystem **106**, a display system **112** (which may include a touch screen), a click wheel **114**, other input or control devices **116**, and an external port **124**. These components may communicate over one or more communication buses or signal lines **103**. The device **100** may be any portable electronic device, including but not limited to a handheld computer, a tablet computer, a mobile phone, a media player, a personal digital assistant (PDA), or the like, including a combination of two or more of these items. In other embodiments, the device **100** may not be portable, such as a desktop personal computer.

It should be appreciated that the device **100** is only one example of a portable electronic device **100**, and that the device **100** may have more or fewer components than shown, may combine two or more components, or a may have a different configuration or arrangement of the components. The various components shown in FIG. **1** may be implemented in hardware, software or a combination of both hardware and software, including one or more signal processing and/or application specific integrated circuits.

The memory **102** may include high speed random access memory and may also include non-volatile memory, such as one or more magnetic disk storage devices, flash memory devices, or other non-volatile solid state memory devices. In some embodiments, the memory **102** may further include storage remotely located from the one or more processors **120**, for instance network attached storage accessed via the RF circuitry **108** or the external port **124** and a communications network (not shown) such as the Internet, intranet(s), Local Area Networks (LANs), Wide Local Area Networks (WLANs), Storage Area Networks (SANs) and the like, or any suitable combination thereof. Access to the memory **102** by other components of the device **100**, such as the CPU **120** and the peripherals interface **118**, may be controlled by the memory controller **122**.

The peripherals interface **118** couples the input and output peripherals of the device to the CPU **120** and the memory **102**. The one or more processors **120** run or execute various software programs and/or sets of instructions stored in the memory **102** to perform various functions for the device **100** and to process data.

In some embodiments, the peripherals interface **118**, the CPU **120**, and the memory controller **122** may be implemented on a single chip, such as a chip **104**. In some other embodiments, they may be implemented on separate chips.

The RF (radio frequency) circuitry **108** receives and sends electromagnetic waves. The RF circuitry **108** converts electrical signals to/from electromagnetic waves and communicates with communications networks and other communications devices via the electromagnetic waves. The RF circuitry **108** may include well-known circuitry for performing these functions, including but not limited to an antenna system, an RF transceiver, one or more amplifiers, a tuner, one or more oscillators, a digital signal processor, a CODEC chipset, a subscriber identity module (SIM) card, memory, and so forth. The RF circuitry **108** may communicate with networks, such as the Internet, also referred to as the World Wide Web (WWW), an Intranet and/or a wireless network, such as a cellular telephone network, a wireless local area network (LAN) and/or a metropolitan area network (MAN), and other devices by wireless communication. The wireless communi-

cation may use any of a plurality of communications standards, protocols and technologies, including but not limited to Global System for Mobile Communications (GSM), Enhanced Data GSM Environment (EDGE), wideband code division multiple access (W-CDMA), code division multiple access (CDMA), time division multiple access (TDMA), Bluetooth, Wireless Fidelity (Wi-Fi) (e.g., IEEE 802.11a, IEEE 802.11b, IEEE 802.11g and/or IEEE 802.11n), voice over Internet Protocol (VoIP), Wi-MAX, a protocol for email, instant messaging, and/or Short Message Service (SMS)), or any other suitable communication protocol, including communication protocols not yet developed as of the filing date of this document.

The audio circuitry **110**, the speaker **111**, and the microphone **113** provide an audio interface between a user and the device **100**. The audio circuitry **110** receives audio data from the peripherals interface **118**, converts the audio data to an electrical signal, and transmits the electrical signal to the speaker **111**. The speaker **111** converts the electrical signal to human-audible sound waves. The audio circuitry **110** also receives electrical signals converted by the microphone **113** from sound waves. The audio circuitry **110** converts the electrical signal to audio data and transmits the audio data to the peripherals interface **118** for processing. Audio data may be retrieved from and/or transmitted to the memory **102** and/or the RF circuitry **108** by the peripherals interface **118**. In some embodiments, the audio circuitry **110** also includes a headset jack (not shown). The headset jack provides an interface between the audio circuitry **110** and removable audio input/output peripherals, such as output-only headphones or a headset with both output (headphone for one or both ears) and input (microphone).

The I/O subsystem **106** provides the interface between input/output peripherals on the device **100**, such as the display system **112**, the click wheel **114** and other input/control devices **116**, and the peripherals interface **118**. The I/O subsystem **106** may include a display controller **156**, a click wheel controller **158** and one or more input controllers **160** for other input or control devices. The one or more input controllers **160** receive/send electrical signals from/to other input or control devices **160**. The other input/control devices **160** may include physical buttons (e.g., push buttons, rocker buttons, etc.), dials, slider switches, sticks, and so forth.

The display system **112** provides an output interface and/or an input interface between the device and a user. The display controller **156** receives and/or sends electrical signals from/to the display system **112**. The display system **112** displays visual output to the user. The visual output may include text, icons, graphics, video, and any combination thereof. In some embodiments, some or all of the visual output may correspond to user-interface objects, further details of which are described below.

In some embodiments, such as those that include a touch screen, the display system **112** also accepts input from the user based on haptic and/or tactile contact. In embodiments with a touch screen, the display system **112** forms a touch-sensitive surface that accepts user input. In these embodiments, the display system **112** and the display controller **156** (along with any associated modules and/or sets of instructions in the memory **102**) detect contact (and any movement or breaking of the contact) on the display system **112** and converts the detected contact into interaction with user-interface objects, such as one or more soft keys, that are displayed on a touch screen. In an exemplary embodiment, a point of contact between a touch screen in the display system **112** and the user corresponds to one or more digits of the user.

In embodiments with a touch screen, the touch screen in the display system **112** may use LCD (liquid crystal display) technology, or LPD (light emitting polymer display) technology, although other display technologies may be used in other embodiments. A touch screen in the display system **112** and the display controller **156** may detect contact and any movement or breaking thereof using any of a plurality of touch sensitivity technologies, including but not limited to capacitive, resistive, infrared, and surface acoustic wave technologies, as well as other proximity sensor arrays or other elements for determining one or more points of contact with a touch screen in the display system **112**. A touch-sensitive display in some embodiments of the display system **112** may be analogous to the multi-touch sensitive tablets described in the following U.S. Pat. No. 6,323,846 (Westerman et al.), U.S. Pat. No. 6,570,557 (Westerman et al.), and/or U.S. Pat. No. 6,677,932 (Westerman), and/or U.S. Patent Publication 2002/0015024A1, each of which is hereby incorporated by reference. However, a touch screen in the display system **112** displays visual output from the portable device **100**, whereas touch sensitive tablets do not provide visual output. The touch screen in the display system **112** may have a resolution in excess of 100 dpi. In an exemplary embodiment, the touch screen in the display system may have a resolution of approximately 168 dpi. The user may make contact with the touch screen in the display system **112** using any suitable object or appendage, such as a stylus, finger, and so forth.

In some embodiments, in addition to touch screen, the device **100** may include a touchpad (not shown) for activating or deactivating particular functions. In some embodiments, the touchpad is a touch-sensitive area of the device that, unlike the touch screen, does not display visual output. The touchpad may be a touch-sensitive surface that is separate from the touch screen in the display system **112** or an extension of the touch-sensitive surface formed by the touch screen.

The device **100** may include a click wheel **114**. A user may navigate among one or more graphical objects (henceforth referred to as icons) displayed in the display system **112** by rotating the click wheel **114** or by moving (e.g., angular displacement) of a point of contact with the click wheel **114**. The click wheel **114** may also be used to select one or more of the displayed icons. For example, the user may press down on at least a portion of the click wheel **114** or an associated physical button. User commands and navigation commands provided by the user via the click wheel **114** may be processed by the click wheel controller **158** as well as one or more of the modules and/or sets of instructions in the memory **102**.

The device **100** also includes a power system **162** for powering the various components. The power system **162** may include a power management system, one or more power sources (e.g., battery, alternating current (AC)), a recharging system, a power failure detection circuit, a power converter or inverter, a power status indicator (e.g., a light-emitting diode (LED)) and any other components associated with the generation, management and distribution of power in portable devices.

In some embodiments, the software components stored in the memory **102** may include an operating system **126**, a communication module (or set of instructions) **128**, a contact/motion module (or set of instructions) **130**, a graphics module (or set of instructions) **132**, one or more applications (or set of instructions) **136**, a timer module (or set of instructions) **144**, a word prediction module (or set of instructions) **146**, an address book **148**, a user word history **150**, one or more character sets **152**, and one or more lexicography models **154**. The graphics module **132** may include an icon effects module

(or set of instructions) **134**. The applications module **136** may include a telephone module (or set of instructions) **138**, a text messaging module (or set of instructions) **140** and/or a music player module (or set of instructions) **142**.

The operating system **126** (e.g., Darwin, RTXC, LINUX, UNIX, OS X, WINDOWS, or an embedded operating system such as VxWorks) includes various software components and/or drivers for controlling and managing general system tasks (e.g., memory management, storage device control, power management, etc.) and facilitates communication between various hardware and software components.

The communication module **128** facilitates communication with other devices over one or more external ports **124** and also includes various software components for handling data received by the RF circuitry **108** and/or the external port **124**. The external port **124** (e.g., Universal Serial Bus (USB), FIREWIRE, etc.) is adapted for coupling directly to other devices or indirectly over a network (e.g., the Internet, wireless LAN, etc.).

The contact/motion module **130** may detect contact with the click wheel **114** and/or a touch screen in the display system **112** (in conjunction with the display controller **156**). The contact/motion module **130** includes various software components for performing various operations related to detection of contact, such as determining if contact has occurred, determining if there is movement of the contact and tracking the movement across the click wheel **114** and/or a touch screen in the display system **112**, and determining if the contact has been broken (i.e., if the contact has ceased). Determining movement of the point of contact may include determining speed (magnitude), velocity (magnitude and direction), and/or an acceleration (including magnitude and/or direction) of the point of contact. In some embodiments, the contact/motion module **130** and the display controller **156** also detects contact on a touchpad.

The graphics module **132** includes various known software components for rendering and displaying graphics on the display system **112**. Note that the term “graphics” includes any object that can be displayed to a user, including without limitation text, web pages, icons (such as user-interface objects including soft keys), digital images, videos, animations and the like.

In some embodiments, the graphics module **132** includes the icon effects module **134**. The icon effects module **134** may modify a displayed position of one or more icons on the display system **112** (in conjunction with the display controller **156**) based on an animation sequence.

In addition to the telephone module **138**, the text messaging module **140** and/or the music player module **142**, the one or more applications **136** may include any applications installed on the device **100**, including without limitation, a browser, the address book **148**, contact list, email, instant messaging, word processing, keyboard emulation, widgets, JAVA-enabled applications, encryption, digital rights management, voice recognition, voice replication, location determination capability (such as that provided by the global positioning system (GPS)), etc. A data structure associated with the address book **148** is discussed further below with reference to FIG. 7.

In conjunction with the RF circuitry **108**, the audio circuitry **110**, the speaker **111**, the microphone **113**, the display system **112**, the display controller **156**, the click wheel **114** and/or the click wheel controller **158**, the telephone module **138** may be used to enter a sequence of characters corresponding to a telephone number, access one or more telephone numbers in the address book **148**, modify a telephone number that has been entered, dial a respective telephone

number, conduct a conversation and disconnect or hang up when the conversation is completed. Embodiments of user interfaces and associated processes corresponding to the telephone module **138** are described further below with reference to FIGS. **3-6**.

In conjunction with the display system **112**, the display controller **156**, the click wheel **114** and/or the click wheel controller **158**, the text messaging module **140** may be used to enter a sequence of characters corresponding to a text message, to modify previously entered characters, to transmit a respective text message (for example, using a Short Message Service or SMS protocol), to receive text messages and to view received text messages. In some embodiments, transmitted and/or received text messages may include graphics, photos, audio files, video files and/or other attachments as are supported in a Multimedia Message Service (MMS) and/or an Enhanced Messaging Service (EMS). Embodiments of user interfaces and associated processes corresponding to the text messaging module **140**, and more generally, to text entry and communication are described further below with reference to FIGS. **8-10**, **12** and **13**.

In conjunction with the display system **112**, the display system controller **156**, the click wheel **114**, the click wheel controller **158**, the audio circuitry **110**, the speaker **111** and/or the microphone **113**, the music player module **142** allows the user to play back recorded music stored in one or more files, such as MP3 or AAC files. In some embodiments, the device **100** may include the functionality of an MP3 player, such as an iPod (trademark of Apple Computer, Inc.). The device **100** may, therefore, include a 36-pin connector that is compatible with the iPod.

The timer module **144** may provide a time reference and/or time stamps for user commands received by the device **100**, for example, using the click wheel **114** and the click wheel controller **158**.

The word prediction module **146** may be used in conjunction with one or more of the applications **136**, such as the text messaging module **140**. The word prediction module **146** may suggest one or more words or symbols (such as punctuation marks, pronunciation marks or spaces) in accordance with a context. The context may be based on one or more of the lexicography models **154** (for example, grammatical and/or syntax rules associated with one or more languages) and/or a user word history **150**. The context may include one or more previously entered words, characters, and/or symbols. The context may depend on which of the applications **136** is being used. For example, there may be different contexts for an email application as opposed to a word processing application.

The user word history **150** may include static content (such as that associated with a dictionary) and/or dynamic content (such as that associated with characters, symbols and/or words that are routinely and/or recently used by the user). The user word history **150** may include a static dictionary built up by scanning a user's address book, emails, and other documents. The user word history **150** may include weighted scores or probabilities for predicted words based on a set of characters, symbols and/or words that are provided by the user to the device **100**, for example, using the click wheel **114** and the click wheel controller **158**. The user word history **150** may also include use statistics (e.g., time of use and/or frequency of use) of one or more characters, symbols and/or words that are provided by the user. The user word history **150** is discussed further below with reference to FIGS. **14A** and **14B**.

The character sets **152** may include one or more sets of characters corresponding to numbers, letters and/or symbols.

The letters and/or symbols may correspond to one or more languages. The character sets **152** may be used by one or more of the applications **136**, such as the text messaging module **140**.

5 In some embodiments, the device **100** may include one or more optional optical sensors (not shown), such as CMOS or CCD image sensors, for use in imaging applications.

In some embodiments, the device **100** is a device where operation of a predefined set of functions on the device is performed exclusively through a touch screen in the display system **112** and/or a touchpad. By using a touch screen and/or a touchpad as the primary input/control device for operation of the device **100**, the number of physical input/control devices (such as push buttons, dials, and the like) on the device **100** may be reduced. In one embodiment, the device **100** includes a touch screen, a touchpad, a push button for powering the device on/off and locking the device, a volume adjustment rocker button and a slider switch for toggling ringer profiles. The push button may be used to turn the power on/off on the device by depressing the button and holding the button in the depressed state for a predefined time interval, or may be used to lock the device by depressing the button and releasing the button before the predefined time interval has elapsed. In an alternative embodiment, the device **100** also may accept verbal input for activation or deactivation of some functions through the microphone **113**.

The predefined set of functions that may be performed exclusively through a touch screen and/or a touchpad include navigation between user interfaces. In some embodiments, the touchpad, when touched by the user, navigates the device **100** to a main, home, or root menu from any user interface that may be displayed on the device **100**. In such embodiments, the touchpad may be referred to as a "menu button." In some other embodiments, the menu button may be a physical push button or other physical input/control device instead of a touchpad.

In some embodiments, the device **100** is a device where operation of a predefined set of functions on the device is performed exclusively or at least in part through the click wheel **114**. By using the click wheel **114** as the primary input/control device for operation of the device **100**, the number of other physical input/control devices (such as push buttons, dials, and the like) on the device **100** may be reduced.

Attention is now directed towards embodiments of user interfaces and associated processes that may be implemented on the device **100**. FIG. **2** is a schematic diagram illustrating an embodiment of a user interface for a portable communication device **300**. The device **300** includes a click wheel **310** and a display **312**. The click wheel constitutes a physical interface for receiving user commands (such as selection of one of more items and/or icons that are displayed on the display **312**) and/or navigation commands (which may, for example, control scrolling through the items and/or icons that are displayed on the display **312**). The user may use the click wheel **310** by touching it (making a point of contact) and then moving the point of contact while maintaining contact. Such angular displacement may indicate a navigation command to scroll through the items and/or icons that are displayed on the display **312**. By pressing down on the click wheel **310**, or a click wheel button **308** (e.g., at the center of the click wheel), the user may select one or more items and/or icons that are displayed on the display **312**. Thus, a pressing down gesture may indicate a user command corresponding to selection.

The device **300** may display a menu or hierarchy of the applications **136** that may be executed or run on the device **300**. Such a menu is illustrated in FIG. **2** in the display **312**. The displayed icons for the applications **136** include 'Favor-

ites' for popular applications for this user, 'Recent' for calls that have been made, answered, and/or missed within a first pre-determined value (such as the last day, week or month), 'Contacts' (which corresponds to the address book **148** in FIG. 1), 'Dial' (which corresponds to the telephone module **138** in FIG. 1) and 'SMS' (which corresponds to the text messaging module **140** in FIG. 1). The 'Music', 'Extras', 'Settings' and 'Now playing' icons may correspond to the music player module **142** (FIG. 1). The arrow icons on the right-hand side of the display **312** may provide a visual clue to the user that selection of a respective icon will move down through the menu hierarchy down to the corresponding application (with a commensurate modification of the information displayed in the display **312**). The display **312** may also include an icon, such as that shown in the upper right-hand corner, that indicates a remaining stored power level for the device **300**.

As discussed previously, if the user selects the 'Dial' icon in the display **312**, the telephone module **138** (FIG. 1) may be executed. Embodiments of telephone user interfaces for the portable communication device **300** that correspond to the telephone module **138** (FIG. 1) are illustrated in FIG. 3A-3D. While the device **300** in these figures has been illustrated with certain components (including displayed information) and a particular arrangement of these components, it should be understood that there may be fewer or more components, two or more components may be combined, and positions of one or more components may be changed.

As shown in FIG. 3A, if a user touches the click wheel **310**, for example with a finger **318** (not drawn to scale in the figure), when the telephone module **138** (FIG. 1) is running, an icon or a set of icons corresponding to a rotary dial image **314_1** may be displayed in the display **312**. Prior to the user touching the click wheel **310**, no image is displayed or an image other than a rotary dial image is displayed (e.g., the menu illustrated in FIG. 2, a sleep mode image, or an image corresponding to another application may be displayed). The rotary dial image **314_1** may correspond to a character entry mode of operation in the telephone module **138** (FIG. 1), e.g., a mode of operation where the user may enter in characters, such as numbers, that correspond to a telephone number the user wishes to dial. In some embodiments, the contact is maintained for more than a second pre-determined time interval prior to the device **100** transitioning to the character entry mode of operation. The second pre-determined time interval may be 0.5, 1 or 2 s.

The rotary dial image **314_1** may include a plurality of icons arranged proximate to a periphery of the rotary dial image. The plurality of icons may include numbers. As shown in FIG. 3A, in some embodiments, the rotary dial image includes the numbers 1-9 arranged as on a clock face, with the 10, 11, and 12 o'clock positions replaced with 0, *, and #, respectively. In other embodiments, the displayed icons are arranged in a pattern corresponding to a conventional rotary dial interface for a telephone.

As shown in FIG. 3A, the display **312** may include icons, such as those shown in the upper left-hand corner, that indicate a signal strength of signals used to communicate with a network, such as a cellular telephone network. The display **312** may include icons **316** corresponding to a sequence of one or more displayed icons that have been previously selected by the user. These icons **316** may be numbers in a set of numbers, e.g., a telephone number, that the user wishes to dial. The selection process is described further below.

By moving a point of contact around at least a portion of the click wheel **310**, the user may provide navigation commands to the device **300**. As discussed previously, the navigation

commands may correspond to scrolling through the icons displayed on the display **312**. For the rotary dial image **314_1**, the scrolling may be around the circumference of the rotary dial image **314_1**. For example, the user may scroll through the icons corresponding to numbers. As shown in FIG. 3B, in some embodiments a respective icon **320**, which corresponds to a current position, may be highlighted. In some embodiments, there is an absolute angular relationship between contact points on the clickwheel **310** and icon positions on the rotary dial image **314** (e.g., the 3 o'clock position on the clickwheel **310** corresponds to the 3 o'clock position in the rotary dial image **314**, the 6 o'clock position on the clickwheel **310** corresponds to the 6 o'clock position in the rotary dial image **314**, etc.).

In some embodiments, in order for the rotary dial image **314_1** to continue to be displayed (e.g., the device **300** remains in the character entry mode of operation) the user maintains the contact with the click wheel **310** even while moving around at least a portion of the click wheel **310** to provide navigation commands. In some embodiments, the rotary dial image **314_1** continues to be displayed even if the user breaks contact with the click wheel **310** if the break in contact is for less than a third pre-determined amount of time or time interval. For example, for time intervals less than 0.5, 1 or 2 s. This functionality may allow the user to break contact with the click wheel **310** while moving around at least a portion of the click wheel **310** (e.g., while providing navigation commands). If the user breaks contact with the click wheel **310**, the navigation commands may be determined based on intervals where there is a point of contact (e.g., in a time interval preceding the breaking of contact and in a time interval after the contact has been reestablished).

The user may select the respective icon **320** (i.e., provide the user command corresponding to selection) by pressing down on the click wheel **310** and/or by pressing on the button **308** (FIG. 2). When the respective icon is selected, a corresponding character or number may be added to the displayed sequence of selected icons **316**.

As shown in FIG. 3C, in some embodiments one or more icons **322** corresponding to one or more letters associated with the respective icon **320** may be displayed in a central region of the rotary dial image **314_1**. As shown in FIG. 3D, in some embodiments sets of one or more icons, such as icon **324**, corresponding to one or more letters associated with at least a subset of the plurality of icons in the rotary dial image **314_1** may be displayed along a radial direction of the rotary dial image **314_1**.

While embodiments of user interfaces for the character entry mode of operation the device **300** have been described, in other embodiments (not shown) the user may use the device **300** to access the address book **148** (FIG. 1) to select one or more telephone numbers that he or she wishes to dial.

When a user has completed entering in a telephone number that he or she wishes to dial, or if the user makes a mistake while entering in the telephone number that he or she wishes to correct, the user may transition to a character correction mode of operation in the telephone module **138** (FIG. 1). Embodiments of telephone user interfaces for a portable communication device **400** that correspond to this mode of operation are illustrated in FIGS. 4A and 4B. While the device **400** in these figures has been illustrated with certain components (including displayed information) and a particular arrangement of these components, it should be understood that there may be fewer or more components, two or more components may be combined, and positions of one or more components may be changed.

The user may transition to the character correction mode of operation by breaking contact with the click wheel **310** or by breaking contact with the click wheel **310** for more than the third pre-determined time interval. When the device **300** transitions to the character correction mode of operation, a new icon or set of icons corresponding to rotary dial image **314_2** may be displayed on the display **312**. The rotary dial image **314_2** has different shading or coloring than the rotary dial image **314_1** (FIGS. 3A-3D) to indicate to the user that the mode of operation has changed.

In some embodiments, the transition from the display of the rotary dial image **314_1** (FIGS. 3A-3D) to the rotary dial image **314_2** is continuous. For example, the rotary dial image **314_1** (FIGS. 3A-3D) may be faded out and the rotary dial image **314_2** may be faded in over a fourth pre-determined time interval. The fourth pre-determined time interval may be 0.5, 1 or 2 s. In some embodiments, the fourth time interval is a time interval greater than a pre-determined value.

In the character correction mode of operation, the user may provide a user command to the device **400** that indicates one or more characters corresponding to one or more previously selected icons should be removed. For example, the user may press on the click wheel **310** over or proximate to a symbol **326** that corresponds to a delete function. When a character is deleted the displayed icons **316** may be modified to indicate the change. As shown in FIG. 4B, in some embodiments an icon or set of icons corresponding to a rotary dial image **314_3** may include icon **330** that provides a visual clue to the user as to the functionality corresponding to the symbol **326** on the click wheel **310**.

After deleting one or more previously selected characters, the user may make contact with the click wheel for at least a fifth pre-determined time interval in order to return to the character entry mode of operation. The fifth pre-determined time interval may be 0.5, 1 or 2 s. In some embodiments, the user may return to the character entry mode of operation by clicking on a predetermined location on the clickwheel **310**, such as symbol **336** on the clickwheel **310**. In some embodiments, the user may return to the character entry mode of operation by moving a point of contact a predetermined amount or angle on the clickwheel **310**. In this mode, the user may select one or more additional icons to complete the sequence of characters corresponding to the telephone number that the user wishes to dial. In some embodiments (not shown in FIG. 4B), rotary dial image **314_3** may include an icon that provides a visual clue to the user as to the functionality corresponding to the symbol **336** on the click wheel **310**, analogous to the visual cue that icon **330** provides for symbol **326**.

If the user does not need to delete any characters or does not need to select any additional characters after deleting one or more characters, the user may provide a user command to the device **400** corresponding to dialing the previously entered telephone number by pressing on the button **308**. An icon **328** in the display **312** may be displayed to provide the user a visual clue as to the current functionality of the button **308**. In some embodiments, one or more additional icons corresponding to one or more functions of the click wheel **310** may be displayed on the display **312** in the device **300** (FIGS. 3A-3B), the device **400** (FIGS. 4A-4B) and/or a device **500** (FIG. 5).

When the user presses on the button **308**, the device **400** may dial the selected telephone number. The device **400**, therefore, may enter a dialing mode of operation. An embodiment of telephone user interfaces for the portable communication device **500** that correspond to this mode of operation is illustrated in FIG. 5. While the device **500** has been illustrated

with certain components (including displayed information) and a particular arrangement of these components, it should be understood that there may be fewer or more components, two or more components may be combined, and positions of one or more components may be changed.

During the dialing mode of operation, an icon or a set of icons corresponding to a rotary dial image **314_4** may be displayed. The rotary dial image **314_4** may be modified during the dialing. The modification may be in accordance with an animation sequence. For example, the rotary dial image **314_4** may be rotated clockwise or counter clockwise. In some embodiments, music, such as a portion of a music file may be played during the dialing.

In some embodiments, the user may adjust a volume of the speaker **111** (FIG. 1) by moving a point of contact with the click wheel **310** approximately clockwise and/or counter clockwise around at least a portion of the click wheel **310**. The device **500** may remain in the dialing mode of operation even if the user maintains the contact with the click wheel **310** for more than a pre-determined time interval, such as the fifth pre-determined time interval.

The rotary dial image **314_4** may include an icon **332** that provides a visual clue to the user as to how he or she should disconnect the telephone call when he or she wishes to. In particular, the icon **322** indicates that by providing a user command (e.g., by pressing on the button **308**) the user may disconnect or end the telephone call. After a respective telephone call is ended, the device **500** may return to the character correction mode of operation.

FIG. 6 is a flow diagram of an embodiment of a telephone number dialing process **600**. While the telephone number dialing process **600** described below includes a number of operations that appear to occur in a specific order, it should be apparent that the process **600** can include more or fewer operations, which can be executed serially or in parallel (e.g., using parallel processors or a multi-threading environment), an order of two or more operations may be changed and/or two or more operations may be combined into a single operation.

A first image of a rotary dial on a display is displayed in response to a first contact by a user with a click wheel (**610**). At least a portion of the first image of the rotary dial is scrolled around in response to one or more navigation commands (**612**). A respective icon in a plurality of icons corresponding to a first position on the first image of the rotary dial is highlighted (**614**). A first user command corresponding to selection of the respective icon is received using the click wheel (**616**). A sequence of one or more selected icons is displayed on the display (**618**). A second image of the rotary dial is optionally displayed on the display in response to the user breaking the first contact with the click wheel (**620**). One or more previously selected icons are optionally removed in response to receiving a second user command (**622**). The second user command may include pressing a delete symbol on the click wheel. A telephone number corresponding to the sequence of selected icons is dialed or disconnected in response to receiving a third user command (**624**). The third user command includes pressing a click wheel button (e.g., **308**).

Attention is now directed towards embodiments of data structures that may be used in implementing the telephone module **138** (FIG. 1) and/or other applications **136** (FIG. 1). FIG. 7 is a block diagram illustrating an embodiment of an address book data structure **700**. The address book **148** may include multiple contacts **712**. A respective contact, such as the contact **712-1**, may include one or more names **714-1**, one or more addresses **716-1**, one or more telephone numbers

718-1, one or more email addresses 720-1, as well as other information 722-1. In some embodiments the address book data structure 700 may include fewer or more components. Two or more components may be combined and an order of two or more components may be changed.

Attention is now directed towards additional embodiments of user interfaces and associated processes that may be implemented on the device 100 (FIG. 1). As discussed previously, if the user selects the 'SMS' icon in the display 312 (FIG. 2), the text messaging module 140 (FIG. 1) may be executed. Embodiments of text messaging user interfaces for a portable communication device 800 that correspond to the text messaging module 140 (FIG. 1) are illustrated in FIGS. 8A-8E and 9A-9B. While the device 800 in these figures has been illustrated with certain components (including displayed information) and a particular arrangement of these components, it should be understood that there may be fewer or more components, two or more components may be combined, and positions of one or more components may be changed.

In FIG. 8A, the device 800 has several trays 810 displayed on the display 312. A respective tray in the trays 810 includes a region of the display 312. A tray 810_1 may be configured to display one or more characters that are selected by the user. The user may select a respective character using the click wheel 310. The user may provide a user command that indicates such a selection in an analogous fashion to that discussed above with reference to FIGS. 3A-3D. A tray 810_2 may include one or more symbols that provide visual clues and/or explanations to the user as to current functions (in a current mode of operation) corresponding to one or more symbols on the click wheel 310. In this way, the user may be alerted to changes in the functionality of the click wheel 310 without changing the symbols on the click wheel 310. In other embodiments, one or more symbols displayed on the click wheel 310 may be modified in accordance with a current function(s) of the click wheel 310. In the embodiment shown in FIG. 8A, the tray 810_2 includes explanations for a delete function, a space function and instructions as to how to obtain a capitalized letter or character. These functions may be selected by pressing on an appropriate portion of the click wheel 310 and/or pressing on the click wheel 310 for at least a sixth pre-determined time interval. For example, the user may obtain a capitalized letter or character by highlighting a corresponding icon on the display 312 and pressing down on the click wheel 310 or a click wheel button 308 for longer than the sixth pre-determined time interval. The letter or character may be selected (i.e., the user command may be provided) when the user presses down on or breaks contact with the click wheel 310 or the button 308. The sixth pre-determined time interval may be 0.5, 1 or 2 s.

A tray 810_3 may include a plurality of icons 812_1 corresponding to a set of characters (in this example, letters in the English alphabet) and one or more recommended words 814. The one or more recommended words 814 may be provided based on a language data structure system 1450 (FIG. 14B). In some embodiments, the one or more recommended words 814 are provided before receiving any characters selected by the user. For example, the one or more recommended words 814 may be in accordance with an application 136 and the user word history 150 (FIG. 1).

As illustrated in FIG. 8A, a current position in the tray 810_3 may be indicated by highlighting (e.g., shading) of a respective icon (a current position icon) in the tray 810_3, in this case, of the word 'hello'. The icons 812_1 and the one or more recommended words 814 may constitute a set. The user may scroll or move through this set by providing navigation commands using the click wheel 310 in an analogous fashion

to that discussed above with reference to FIGS. 3A-3D. In some embodiments, the user may provide a plurality of user commands using the click wheel 310, including selection of multiple icons, while maintaining contact with the click wheel 310. Thus, the user may provide navigation commands (by moving a point of contact with at least a portion of the click wheel 310) and user commands (by pressing on the click wheel 310) while maintaining contact with the click wheel 310. This may increase a number of characters, symbols and/or words that the user may select per minute and may make it easier for the user to use the device 800.

In some embodiments, the device 800 includes one or more additional trays. This is illustrated in FIG. 8B, which includes a tray 810_4. The tray 810_4 may include a plurality of icons 812_2 corresponding to a set of characters (in this case, numbers). In some embodiments, the icons 812_1, the icons 812_2 and the one or more recommended words 814 may constitute a set. The user may scroll or move through this set by providing navigation commands using the click wheel 310 in an analogous fashion to that discussed above with reference to FIGS. 3A-3D.

The tray 810_4 may include icons corresponding to inserting a space in a message and to sending a message. The user may select one of these icons by providing commands using the click wheel 310. In some embodiments, a space may be automatically added after one or more of the recommended words 814 (FIG. 8A) are selected by the user.

In some embodiments, the tray 810_3 may include a display adjustment icon 816. If the user selects the display adjustment icon 816, additional icons may be displayed in the tray 810_3. This is illustrated in FIG. 8C. After selecting the display adjustment icon 816, the one or more recommended words 814 (FIG. 8A) are replaced by icons corresponding to punctuation marks 818. In some embodiments, selecting the display adjustment icon 816 a second time will replace the icons corresponding to punctuation marks 818 with the one or more recommended words 814 (FIG. 8A).

In some embodiments, other icons corresponding to additional characters or sets of characters may be displayed if the display adjustment icon 816 is selected a second time and if the user presses down on the click wheel 310 or the click wheel button 308 for longer than a pre-determined time interval, such as the sixth pre-determined time interval. This is illustrated in FIG. 8D, which shows icons 812_3 (which in this case correspond to numbers).

In some embodiments, a space that was automatically added to a message after one or more of the recommended words 814 (FIG. 1) was selected may be automatically removed if a next user command corresponds to the display adjustment icon 816. For example, if selecting the display adjustment icon 816 corresponding to the displaying of the icons corresponding to the punctuation marks 818 (FIG. 8C), the automatically added space may not be needed in the message and may, therefore, be automatically removed.

Depending on the character sets that are being used by the user, in some embodiments the device 800 may display one or more icons corresponding to pronunciation marks 820 after a respective icon is selected. This is illustrated in FIG. 8E, which shows icons corresponding to pronunciation marks 820 displayed in the tray 810_3. Selecting one of these icons may modify the previously selected respective icon to include the corresponding pronunciation mark.

FIGS. 9A and 9B illustrate additional embodiments of user interfaces for text messaging. In FIG. 9A, tray 810_1 displays a message that is being composed, including characters and/or words that have been previously selected by the user. Tray 810_3 includes a plurality of icons, including a 'JUMP' icon

910 and alternate character set icons 912 and 914. Selecting one or the alternate character set icons 912 and 914 may result in additional icons corresponding to additional character sets being displayed on the display 312. Selecting the 'JUMP' icon 910 may lead to a discontinuous change in the current position in the tray 810_3. This is illustrated in FIG. 9B, which shows the highlighting corresponding to the current position moving from the 'JUMP' icon 910 to the number 6.

FIG. 10 is a flow diagram of an embodiment of a text entry process 1000. While the text entry process 1000 described below includes a number of operations that appear to occur in a specific order, it should be apparent that the process 1000 can include more or fewer operations, which can be executed serially or in parallel (e.g., using parallel processors or a multi-threading environment), an order of two or more operations may be changed and/or two or more operations may be combined into a single operation.

A first tray and a second tray are displayed (1010). The first tray is configured to display one or more characters selected by a user using a click wheel and the second tray may include a first plurality of icons corresponding to characters and one or more recommended words. At least a portion of the first plurality of icons and one or more recommended words are scrolled through in accordance with one or more navigation commands received from the click wheel (1012). A third tray is optionally displayed (1014). The third tray includes a second plurality of icons. The second plurality of icons includes numbers. A respective icon in the first plurality of icons corresponding to a current position in the second tray is highlighted (1016). A first user command corresponding to selection of the respective icon is received (1018). The first user command may include pushing down on the click wheel or a click wheel button. In some embodiments, after the first user command is received, the respective icon remains highlighted. In other embodiments, after the first user command is received, the first recommended word icon is highlighted, which makes it easier for the user to select the first recommended word. Explanation of one or more functions corresponding to one or more symbols on the click wheel may be optionally displayed on the display (1020). A space may be automatically added after receiving a second user command (1022). The second user command may correspond to a selection of one or more of the recommended words. Icons corresponding to punctuation marks may be optionally displayed in accordance with one or more characters that are selected by the user (1024).

A sensitivity of the scrolling through the trays 810 in FIGS. 8A-8E and 9A-9B as a function of the motion of the point of contact by the user may be adjusted and/or varied over time. Similar adjustment and/or variation in the scrolling sensitivity may be implemented in other applications 136 (FIG. 1), such as the telephone module 138. FIG. 11 is a flow diagram of an embodiment of a scrolling process 1100. While the scrolling process 1100 described below includes a number of operations that appear to occur in a specific order, it should be apparent that the process 1100 can include more or fewer operations, which can be executed serially or in parallel (e.g., using parallel processors or a multi-threading environment), an order of two or more operations may be changed and/or two or more operations may be combined into a single operation.

A plurality of icons displayed on a display are scrolled through (1110). The scrolling is in accordance with a speed and/or an acceleration of a point of contact by a user with a click wheel. In some embodiments, a scroll rate is slower for a pre-determined angular displacement of the contact just after the scrolling is started, just prior to stopping the scrolling

and/or when a direction of the scrolling is reversed (1112). In some embodiments, a scroll rate is slower for a pre-determined time interval of the contact just after the scrolling is started, just prior to stopping the scrolling and/or when a direction of the scrolling is reversed (1114).

Attention is now directed towards additional embodiments of user interfaces and associated processes for implementing replay recommendations on the device 100 (FIG. 1). One challenge associated with using the click wheel 310 (FIG. 9B) is that it may be difficult for the user to navigate within an existing message to correct an error, such as a spelling or lexicography error. As a consequence, the user may have to delete multiple words in the message in order to fix the error. In the user interface and process described below, at least some of the words in an existing message that are deleted may be replayed, i.e., provided to the user as recommended words, in a reverse sequential order to that when the words were deleted. In this way, it may be easier for a user to reconstruct the remainder of the message after correcting the error.

The device 100 (FIG. 1) may determine that there is a potential replay condition, i.e., that it may be appropriate to provide one or more recommended words as part of a replay recommendation, based on the user deleting one or more previously entered words in a message. In some embodiments, the potential replay recommendation may be in accordance with zero or more additional words, characters or symbols that the user adds to the message after deleting one or more words.

The user may select one or more of the recommended words in such a replay recommendation using the click wheel 114 (FIG. 1) or by making a gesture (such as a swipe) on a touch-sensitive display in the display system 112 (FIG. 1). Once a word is accepted, it may be removed from the recommended words and a next word in the reverse sequence of previously deleted words may be provided/recommended.

FIGS. 12A-12C are schematic diagrams illustrating embodiments of user interfaces that may be implemented on a device 1200 during a replay recommendation process. While the device 1200 in these figures has been illustrated with certain components (including displayed information) and a particular arrangement of these components, it should be understood that there may be fewer or more components, two or more components may be combined, and positions of one or more components may be changed.

In FIG. 12A, a current set of characters 1210_1 that have been selected by the user (e.g., based on a sequence of user commands provided by the user) include a spelling error. The current set of characters 1210_1 includes a current sequence of words. In some embodiments, the current set of characters 1210_1 includes a grammatical error and/or a lexicography error. In some embodiments, the current set of characters 1210_1 includes a misspelled word (e.g., "djde", as shown in FIG. 12A) or an extra word (e.g., "Hey dude, how how are you doing?", not shown). In some embodiments, the current set of characters 1210_1 is missing a word (e.g., "Hey dude, are you doing?", not shown). The user commands may be provided using the click wheel 310. In other embodiments, the user commands may be provided using one hand or one finger, for example, using a touch-sensitive display.

In FIG. 12B, the user has deleted (i.e., provided user commands to delete) characters in the current set of characters, resulting in a new current set of characters 1210_2. Based on a determination of a potential replay condition, the device 1200 displays replay recommendations in the recommended words 814. These correspond to at least a subset of the previously deleted words from the current set of characters 1210_1. These previously deleted words are presented in

reverse sequential order relative to an order in which at least the subset of the deleted words was deleted.

In FIG. 12C, the user has selected one or the recommended words 814. The word is added to a current set of characters 1210_3 and is removed from the recommended words 814. A next deleted word in the reverse sequential order of deleted words is displayed with the recommended words 814. This process may be repeated until the message is completed, i.e., the current set of characters 1210_1 (FIG. 12A) is restored without the spelling error (i.e., the spelling error in 1210_1 is corrected).

In some embodiments, the recommended words 814 may include additional words, characters and/or symbols that were not deleted. These words, characters and/or symbols may be determined using the language data structure system 1450 (FIG. 14B). In some embodiments, the additional recommendations may include punctuation marks and/or pronunciation marks.

In some embodiments, a space may be automatically inserted in the message after one or more of the recommended words 814 are accepted. In some embodiments, such a space is automatically removed if a next user command corresponds to selection of a punctuation mark. In some embodiments, one or more words in the current sequence of words 1210_3 may be capitalized in accordance with a context of the one or more words, characters and/or symbols in the current sequence of words 1210_3.

FIG. 13 is a flow diagram of an embodiment of a replay recommendation process 1300. While the replay recommendation process 1300 described below includes a number of operations that appear to occur in a specific order, it should be apparent that the process 1300 can include more or fewer operations, which can be executed serially or in parallel (e.g., using parallel processors or a multi-threading environment), an order of two or more operations may be changed and/or two or more operations may be combined into a single operation.

A current set of characters is received in response to user commands (1310). The set of characters includes a sequence of words. Additional user commands that specify characters to delete from and/or add to the current set of characters are received (1312). Replay recommendations for words to be added to the current set of characters are provided (1314). The replay recommendations include one or more deleted words that correspond to the deleted characters. A user command corresponding to acceptance of a respective recommended word is received, the respective recommended word is removed from the replay recommendations, and the respective word is added to the current set of characters (1316). Operations 1312 and 1314 may be optionally repeated 1318.

Attention is now directed towards embodiments of data structure systems that may be used in implementing the text messaging module 140 (FIG. 1), the text entry process (1000), the replay recommendation process 1300 (FIG. 13) and/or other applications 136 on the device 100 (FIG. 1). FIG. 14A is a block diagram illustrating an embodiment of a user word history data structure 1400. The user word history 150 may include a deleted word stack 1410 and multiple words 1416. The words 1416 may include one or more characters and/or one or more symbols. The deleted word stack 1410 includes one or more words 1414 in a sequential order in which the one or more words 1414 were deleted by the user in an application, such as the text messaging module 140 (FIG. 1). The deleted word stack 1410 may be used in the device 1200 (FIGS. 12A-12C) and in the replay recommendation process 1300 (FIG. 13).

A respective word in the words 1416, such as word 1416-M, may include multiple records. A respective record may include a time-weighted score 1418, use statistics 1420 (such as a time of use and/or a frequency of use), a context 1422 and one or more applications 1424. The time-weighted score 1418 may indicate a probability that the word 1416-M is a next predicted word based on the context 1422 (one or more characters, symbols and/or words that have previously been provided by the user) and/or the application 1424. For example, the time-weighted score 1418 for an email application may be different than the time-weighted score for the text messaging module 140 (FIG. 1). The time-weighted score 1418 may be computed to favorably weight (e.g., give a higher probability) to words that are used recently. For example, the time-weighted score 1418 may give favorable weighting to words 1416 that are used within the last 24 hours or week. Words 1416 used on longer time scales (e.g., more than a day or a week ago) may have their corresponding time-weighted scores 1418 reduced by a pre-determined ratio (such as 0.9) for each additional time interval (e.g., each day or week) since the words 1416 were last used.

The user history data structure 1400 may include static information (for example, corresponding to a dictionary and/or grammatical and syntax rules for one or more languages) as well as dynamic information (based on recent usage statistics and/or patterns). The user word history data structure 1400 may include a static dictionary built up by scanning a user's address book, emails, and other documents. The user history data structure 1400 may be dynamically updated continuously, after pre-determined time intervals, or when a new word or syntax is employed by the user. In some embodiments the user history data structure 1400 may include fewer or more components. Two or more components may be combined and an order of two or more components may be changed.

FIG. 14B is a block diagram illustrating an embodiment of a language data structure system 1450. The data structure system 1450 may be used to provide recommended words in the device 800 (FIGS. 8A-8E). A sequence of symbols 1462 (including one or more characters, symbols and/or words) may be provided by the user. A set of symbols 1462 corresponding to a context 1422-1 may be processed by a context map 1460. In some embodiments, the context 1422-1 may be a null set, e.g., one or more recommended words are provided before the user provides any symbols 1462 in a current application session. In other embodiments, the context 1422-1 may include one or more previously entered or provided words as well as one or more symbols, such as the first one, two or three letters in a current word that the user is providing. The context map 1460 may include a select and hashing module 1464 and a hash map 1466. The hash map 1466 may select one or more appropriate entries in an application-specific dictionary 1468. The entries in the application-specific dictionary 1468 may include contexts 1470, predicted words 1472, and time-weighted scores 1472. The application-specific dictionary 1468 may utilize the records in the user history data structure 1400. As a consequence, the application-specific dictionary 1468 may be dynamically updated continuously, after pre-determined time intervals, or when a new word or syntax is employed by the user.

The language data structure system 1450 may be used to provide one or more recommended words based on the context 1422-1. The context map 1460 may find a top-5 or top-10 best context 1470 matches. The corresponding predicted words 1472 may be recommended to the user in accordance with the time-weighted scores 1474. In some embodiments, only a subset of the predicted words 1470 corresponding to

the best context **1470** matches may be presented to the user (e.g., just the top-1, top-2, or top-3 predicted words).

In some embodiments, the language data structure system **1450** may provide one or more recommended words in accordance with a state machine (corresponding to a Markov sequence or process) that corresponds to a language. For example, the application-specific dictionary **1468** may be based on a stochastic model of the relationships among letters, characters, symbols and/or words in a language.

A path memory (such as up to three characters in a word that is currently being entered and/or two or three previously entered words) of the probabilistic model represents a tradeoff between accuracy and the processing and power capabilities (for example, battery life) of the portable communication device **100** (FIG. 1). In some embodiments, such a probabilistic model may be based on a lexicography and usage that is user-specific and/or, as discussed previously, even application specific. For example, user emails, address book and/or other documents may be analyzed to determine an appropriate probabilistic model for that user based on the syntax and/or lexicography (including names and slang) that are employed by the user. The probabilistic model may be updated continuously, after pre-determined time intervals, or when a new word or syntax is employed by the user.

In some embodiments, the probabilistic model may be based on one or more mistakes made by the user when using the click wheel **114** (FIG. 1) and/or a touch-sensitive display in the display system **112** (FIG. 1). For example, if the user accidentally selects the wrong icon when typing a respective word, the probabilistic model may be updated to account for such errors in the future. In an exemplary embodiment, a mistake may be determined based on a user activation of an icon corresponding to the delete function. This adaptability of the portable communication device **100** (FIG. 1) may allow correction of user interface errors (such as parallax and/or left-right symmetry) associated with which finger(s) the user is using and how the user is holding the portable communication device **100** (FIG. 1) while using it. This adaptability of the portable communication device **100** (FIG. 1) may also be used to prevent the recommendation of misspelled words (e.g., by deleting such words from the user word history **150** or giving such words very low weighted scores).

In some embodiments the language data structure system **1450** may include fewer or more components. Two or more components may be combined and an order of two or more components may be changed.

The foregoing descriptions of specific embodiments of the present invention are presented for purposes of illustration and description. They are not intended to be exhaustive or to limit the invention to the precise forms disclosed. Rather, it should be appreciated that many modifications and variations are possible in view of the above teachings. The embodiments were chosen and described in order to best explain the principles of the invention and its practical applications, to thereby enable others skilled in the art to best utilize the invention and various embodiments with various modifications as are suited to the particular use contemplated.

What is claimed is:

1. A method, comprising:

at a portable communication device having a display and a click wheel:

detecting a first input on the click wheel;

in response to detecting the first input:

displaying a telephone user interface on the display, including a current image of a rotary dial, wherein the current image of the rotary dial provides visual

clues as to the functionality of the click wheel for a current mode of operation; and

entering a first mode of operation, wherein, in the first mode of operation, the current image of the rotary dial is a first image of the rotary dial including a plurality of icons arranged proximate to a periphery of the rotary dial, the plurality of icons include numbers, and there is an absolute angular relationship between respective contact points on the click wheel and corresponding icon positions on the first image of the rotary dial;

detecting a second input on the click wheel; and

in response to the second input, entering a second mode of operation distinct from the first mode of operation, wherein, in the second mode of operation, the current image of the rotary dial is a second image of the rotary dial including a different shading pattern than the first image of the rotary dial.

2. The method of claim 1, wherein the first input includes a first contact by the user with the click wheel, and the method further comprises scrolling around at least a portion of the first image of the rotary dial in response to one or more navigation commands received from the click wheel, wherein the one or more navigation commands correspond to the user moving the first contact around at least a portion of the click wheel.

3. The method of claim 1, further comprising highlighting a respective icon in the plurality of icons corresponding to a current position on the first image of the rotary dial.

4. The method of claim 1, wherein one or more letters corresponding to a respective icon in the plurality of icons are displayed along a radial direction of the first image of the rotary dial.

5. The method of claim 1, wherein one or more letters corresponding to a respective icon in the plurality of icons are displayed in a central region of the first image of the rotary dial.

6. The method of claim 1, further comprising receiving a user command using the click wheel, wherein the user command corresponds to a selection of a respective icon in the plurality of icons, and wherein the user command includes pushing down on the click wheel.

7. The method of claim 1, further comprising displaying a sequence of one or more selected icons in the display.

8. The method of claim 1, wherein:

the first input includes a first contact by a user with a click wheel; and

the second input includes the user breaking the first contact with the click wheel.

9. The method of claim 8, wherein breaking the first contact with the click wheel includes breaking the first contact for a time interval greater than a pre-determined value.

10. The method of claim 1, wherein, when the device enters the second mode of operation, the first image of the rotary dial is faded out and the second image of the rotary dial is faded in over a pre-determined time interval.

11. The method of claim 1, wherein the first image of the rotary dial corresponds to a character entry mode of operation and the second image of the rotary dial corresponds to a character correction mode of operation.

12. The method of claim 1, further comprising removing one or more previously selected icons in response to receiving a user command using the click wheel, wherein the user command includes pressing on a delete symbol on the click wheel.

23

13. The method of claim 12, wherein the second image of the rotary dial includes an icon corresponding to the delete symbol on the click wheel.

14. The method of claim 1, further comprising dialing a telephone number corresponding to a sequence of selected icons in response to receiving a first user command, wherein the first user command includes pressing a button at the center of the click wheel.

15. The method of claim 14, further comprising modifying the first image of the rotary dial in accordance with an animation sequence during the dialing.

16. The method of claim 14, further comprising playing a portion of a music file during the dialing.

17. The method of claim 14, further comprising disconnecting from the dialed telephone number in response to receiving a second user command, wherein the second user command includes pressing the button at the center of the click wheel.

18. The method of claim 14, further comprising adjusting volume during a telephone call in response to motion of a second contact by the user with the click wheel around at least a portion of the click wheel.

19. A graphical user interface on a portable communication device with a display and a click wheel, comprising:

a telephone user interface including a current image of the rotary dial, wherein the current image of the rotary dial provides visual clues as to the functionality of the click wheel for a current mode of operation, wherein:

in response to detecting a first input on the click wheel:

the current image of the rotary dial is displayed; and

a first mode of operation is entered, wherein, in the first mode of operation, the current image of the rotary dial is a first image of the rotary dial including a plurality of icons arranged proximate to a periphery of the rotary dial, the plurality of icons include numbers, and there is an absolute angular relationship between respective contact points on the click wheel and corresponding icon positions on the first image of the rotary dial; and,

in response to detecting a second input on the click wheel, a second mode of operation distinct from the first mode of operation is entered, wherein, in the second mode of operation, the current image of the rotary dial is a second image of the rotary dial including a different shading pattern than the first image of the rotary dial.

20. A computer program product for use in conjunction with a portable communications device having a display and a click wheel, the computer program product comprising a computer readable storage medium and a computer program mechanism embedded therein, the computer program mechanism comprising instructions for:

detecting a first input on the click wheel;

in response to detecting the first input:

displaying a telephone user interface on the display, including a current image of a rotary dial, wherein the current image of the rotary dial provides visual clues as to the functionality of the click wheel for a current mode of operation; and

entering a first mode of operation, wherein, in the first mode of operation, the current image of the rotary dial is a first image of the rotary dial including a plurality of icons arranged proximate to a periphery of the rotary dial, the plurality of icons include numbers, and there is an absolute angular relationship between respective contact points on the click wheel and corresponding icon positions on the first image of the rotary dial;

detecting a second input on the click wheel; and,

24

in response to detecting the second input, entering a second mode of operation distinct from the first mode of operation, wherein, in the second mode of operation, the current image of the rotary dial is a second image of the rotary dial including a different shading pattern than the first image of the rotary dial.

21. A portable communications device, comprising:

a display;

a click wheel;

one or more processors;

memory; and

a program, wherein the program is stored in the memory and configured to be executed by the one or more processors, the program including instructions for:

detecting a first input on the click wheel;

in response to detecting the first input:

displaying a telephone user interface on the display, including a current image of a rotary dial, wherein the current image of the rotary dial provides visual clues as to the functionality of the click wheel for a current mode of operation; and

entering a first mode of operation, wherein, in the first mode of operation, the current image of the rotary dial is a first image of the rotary dial including a plurality of icons arranged proximate to a periphery of the rotary dial, the plurality of icons include numbers, and there is an absolute angular relationship between respective contact points on the click wheel and corresponding icon positions on the first image of the rotary dial;

detecting a second input on the click wheel; and,

in response to detecting the second input, entering a second mode of operation distinct from the first mode of operation, wherein, in the second mode of operation, the current image of the rotary dial is a second image of the rotary dial including a different shading pattern than the first image of the rotary dial.

22. The method of claim 1, wherein the first image of the rotary dial is an image of an entire rotary dial.

23. The method of claim 1, wherein the first image of the rotary dial comprises a circle and the icons are evenly spaced proximate to a periphery of the image of the rotary dial.

24. The method of claim 1, wherein the click wheel is touch sensitive and is coplanar with the display.

25. The method of claim 1, wherein the first input includes a first contact by a user with a click wheel, and the click wheel is configured to detect movement of the first contact around the click wheel, the method further comprising: scrolling through the plurality of icons arranged proximate to the periphery of the rotary dial in accordance with an angular displacement of the first contact from an initial point of contact with the click wheel.

26. The method of claim 1, wherein the first input includes a first contact by a user with a click wheel, and the click wheel is configured to detect movement of the first contact around the click wheel, the method further comprising: scrolling through the plurality of icons arranged proximate to the periphery of the rotary dial in accordance with an angular position of the first contact.

27. The method of claim 1, wherein the click wheel is a touch sensitive surface, the method further comprising:

in response to a first command, performing a first operation, wherein the first command includes a contact with the click wheel;

in response to a second command, performing a second operation, wherein the second command includes pressing on the click wheel;

25

in response to a third command, performing a third operation, wherein the third command includes pressing a button in the center of a click wheel; and wherein the first operation, the second operation and the third operation are each distinct operations. 5

28. The method of claim 1, wherein:
the first mode of operation is a character entry mode of operation; and
the second mode of operation is a character correction mode of operation. 10

29. The method of claim 1, further comprising:
detecting a third input on the click wheel; and
in response to the third input, entering a third mode of operation distinct from the first mode of operation and the second mode operation, wherein, in the third mode of operation, the current image of the rotary dial is a third image of the rotary dial including a different shading pattern than both the first image of the rotary dial and the second image of the rotary dial. 15

26

30. The method of claim 29, wherein:
the first mode of operation is a character entry mode of operation, wherein while the device is in the character entry mode of operation, the current image of the rotary dial provides visual clues as to the absolute angular relationship between contact points on the click-wheel and characters on the rotary dial;
the second mode of operation is a character correction mode of operation, wherein while the device is in the character correction mode of operation, the current image of the rotary dial provides visual clues as to character deletion functionality; and
the third mode of operation is a dialing mode of operation, wherein while the device is in the dialing mode of operation, the current image of the rotary dial provides visual clues as to telephone call disconnection functionality.

* * * * *

UNITED STATES PATENT AND TRADEMARK OFFICE
CERTIFICATE OF CORRECTION

PATENT NO. : 7,860,536 B2
APPLICATION NO. : 11/459609
DATED : December 28, 2010
INVENTOR(S) : Steven P. Jobs et al.

Page 1 of 1

It is certified that error appears in the above-identified patent and that said Letters Patent is hereby corrected as shown below:

On page 2, in column 1, under "Other Publications", line 1, delete "Interaktive" and insert -- Interactive --, therefor.

On page 2, in column 2, under "Other Publications", line 20, delete "http://www. digitwireless" and insert -- http://www.digitwireless --, therefor.

On page 2, in column 2, under "Other Publications", line 38, delete "20cell1" and insert -- 20cell --, therefor.

In column 11, line 22, delete "FIG." and insert -- FIGS. --, therefor.

In column 25, line 15, in claim 29, after "mode" insert -- of --.

Signed and Sealed this
First Day of November, 2011

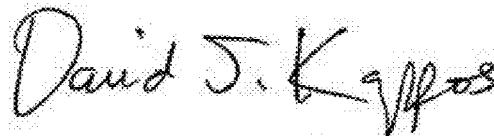

David J. Kappos
Director of the United States Patent and Trademark Office